

COMPETENCY BROCHURE

# **BIM – DIGITAL PLANNING AND BUILDING**

**WITH DATA AND SOFTWARE FROM GEBERIT**



**KNOW  
HOW  
INSTALLED**

# FOREWORD

Building Information Modelling (BIM) equates to Industry 4.0 for the construction industry. Against the background that BIM will bring about fundamental changes, it will also call for a fundamental rethinking in the construction and plumbing products industry in addition to the necessary technical adjustments.

At Geberit, BIM represents much more than simply the provision of additional 3D data formats. To a much greater extent, we wish to provide our customers with integrated solutions to make digital planning with our products as simple as possible. Following extensive development work and ongoing feedback from research and industry, we have succeeded in getting innovative solutions for digital construction off the ground. We hope that this brochure will introduce our BIM strategy to you as well as our view of manufacturer's BIM content and provide you with future-centric concepts demonstrating that the future of digital construction has already started at Geberit.



Christian Buhl  
CEO



Werner Trefzer  
Head Technical Documentation & BIM

# CONTENTS

---

<b>1</b>	<b>HISTORY</b>	
1.1	Development of construction planning	7
1.2	Development of BIM	11
<b>2</b>	<b>PRINCIPLES</b>	
2.1	BIM	13
2.1.1	Definition	13
2.1.2	Dimensions of BIM	14
2.1.3	The BIM process	14
2.1.4	Elements	15
2.1.5	Purpose	16
2.1.6	Benefits	17
2.2	The BIM model	18
2.2.1	Definition of a model	18
2.2.2	Features	19
2.2.3	Central model versus federated model	20
2.2.4	Reference model and discipline models	21
2.2.5	Open BIM versus closed BIM	22
2.3	The BIM object	23
2.3.1	Features	23
2.3.2	Level of detail (LOD)	24
2.3.3	Generic versus manufacturer-specific	24
2.3.4	Data sharing	25
2.3.5	Data formats	26
2.4	BIM in the construction industry	27
2.4.1	Status	27
2.4.2	Challenges for construction product manufacturers	30
<b>3</b>	<b>STANDARDS AND GUIDELINES</b>	
3.1	Overview	35
3.2	International standards	36
3.2.1	Overview	36
3.2.2	ISO 19650	36
3.2.3	ISO 16739	36
3.2.4	ISO 29481	36
3.2.5	ISO 16757	37

---

3.2.6	ISO 12006	37
3.2.7	ISO 23386	37
3.2.8	BS 1192	38
3.3	Local standards	38
3.3.1	Germany	38
3.3.2	Austria	39
3.3.3	Switzerland	39
3.4	Guidelines and specifications	40
3.4.1	VDI 2552	40
3.4.2	VDI 3805	41
3.4.3	DIN SPEC 91350	43
3.4.4	DIN SPEC 91391	43
3.4.5	NBS BIM Object Standard	43
3.4.6	COBie	43
3.5	Associations, bodies and projects	44
3.5.1	buildingSMART	44
3.5.2	Normalisation and standardisation bodies	44
3.5.3	Planen-bauen 4.0	44
3.5.4	Federal Ministry of Transport and Digital Infrastructure Road Map	45
3.5.5	CAFM-Connect	45
<b>4</b>	<b>SOLUTIONS</b>	
4.1	Existing procedure	47
4.2	Scale of the Geberit product range	47
4.3	Geberit online survey	48
4.3.1	Background and objectives	48
4.3.2	Methodology and execution	48
4.3.3	Sampling and response rate	48
4.3.4	The key results at a glance	48
4.3.5	Results in detail	50
4.4	Bodies and cooperations	76
4.4.1	Geberit in BIM bodies	76
4.5	Geberit data and software solutions	77
4.5.1	Classification of Geberit BIM objects	77
4.5.2	Geberit BIM Catalogue plug-in	78
4.5.3	Geberit ProPlanner	82
4.5.4	Geberit Pluvia plug-in for Autodesk® Revit®	86

CHAPTER ONE

# HISTORY



## 1.1 DEVELOPMENT OF CONSTRUCTION PLANNING

Since man first erected buildings, the method of construction has constantly evolved over the millennia. From the ancient times to the Middle Ages, all the work on a construction project took place directly on the construction site. Everyone involved in the construction project, from the builder to the craftsmen, worked on site so that matters could be agreed quickly and easily. The place of execution was therefore also the planning site.

Although in very early times there were no drawings or plans as buildings still had a very simple design, the increasing complexity of buildings meant that it became more and more important to define ideas and building structures in the form of sketches and notes in advance of a construction project and continuously adapt and refine them during the construction period. Today it is hard to imagine, for example, that huge, architecturally complex cathedrals were constructed in the Middle Ages using these simple methods.

In the Middle Ages, builders mainly worked with sketch books in which they wrote down their ideas. Detailed construction plans, such as we have today, were unknown back then. It was therefore also common for all the knowledge about such a large project to be known to only a few people involved in the construction. Time and time again, major construction projects came to a standstill over longer periods of time when this knowledge was lost. It was often a very difficult undertaking for subsequent builders to continue such a project. A prominent example of this kind of situation is Cologne Cathedral, which was officially completed in 1880 after a total construction period of around 632 years and an interruption to the construction lasting almost three hundred years.

Knowledge about mass and proportions increased during the transition from the Middle Ages to the Renaissance, partly due to the rediscovery of ancient writings. Builders' sketch books evolved into scaled construction plans, supplemented by extensive static calculations. This development put an end to the necessity to be permanently present on the construction site. Away from the construction site, builders could plan the construction projects, but, above all, also work simultaneously on multiple construction projects. The planning site was no longer

the place of execution. The separation of planning and execution, driven by the increasing complexity of construction projects, led to the increased specialisation of all those involved in the construction project: the job description of the builder, for instance, differed from the job description of the architect and construction engineer. This specialisation resulted in the much greater need for coordination work between the individual stakeholders.



Figure 1: Medieval construction sketch by Villard de Honnecourt

***“The role of builders/architects has changed considerably. While Brunelleschi, as a traditional builder, managed the planning and execution of the construction of the Santa Maria del Fiore Cathedral between 1418 and 1436, at the same time as inventing machinery to build the dome, Christopher Wren managed the planning of the construction of St. Paul’s Cathedral between 1675 and 1710 but was only responsible for supervising its actual construction. When constructing the Capitol between 1851 and 1863, the architect Thomas U. Walter only managed the planning. Montgomery C. Meigs of the Army Corps of Engineers managed the construction, and the actual construction work was done by a building company (a general contractor).”***

[MacLeamy 2007, quoted from Hausknecht, Liebich – BIM-Kompodium (BIM Compendium): 2016]

Construction projects attained such a degree of complexity in the 20th and 21st centuries that new forms of planning and coordination became necessary. More and more specialists were involved in the creation of a building and in the planning and calculation of complex construction projects that the generalist role of a classic builder changed more and more. The introduction of computers into construction planning, which occurred progressively from the 1980s onwards, marked another fundamental shift. Whereas many functions still had to be programmed by specialists in the early 1980s, increasingly powerful software applications began to dominate the construction sector. Following the move from the drawing board to 2D computer-assisted planning, the next step to so-called Computer-Aided Design (CAD) occurred in the years that followed. Even today, 3D CAD planning shapes everyday design work in the construction industry.

BIM moves construction planning fully into the digital age. From initial planning with pen and paper to computer-based planning, BIM represents a new stage of development encompassing the entire life cycle of a building, from its concept phase right through to demolition. The planning, construction and operation of buildings on the basis of intelligent 3D CAD models is a logical next step, which goes hand in hand with the development of increasingly powerful tools, such as hardware and software.

Until the invention of the computer and its use for construction planning, people worked almost exclusively with hand-drawn plans and additional notes or transcripts of building properties. All the knowledge about the entire building and processes was held solely in the minds of the skilled persons involved with the construction.

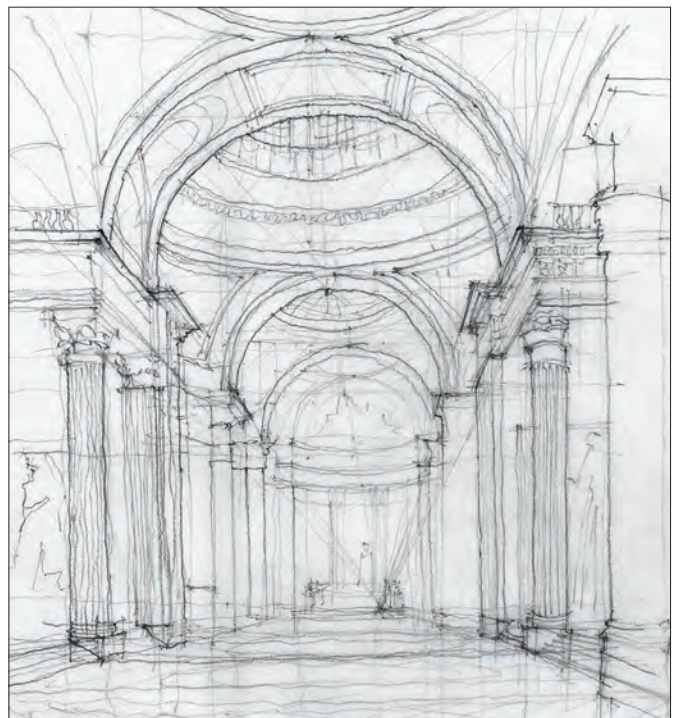

Figure 2: The past: hand-drawn view of the interior of a building



Figure 3: Today: printed CAD building plan

The era of hand-drawn construction plans ended with the introduction of computers into construction planning. CAD provides the opportunity of developing construction plans on a screen in a 2D or 3D environment. However, paper is still far from being obsolete in terms of carrying information. The construction plans created on a computer need to be printed (or "plotted") for use on the construction site so the paper form of the plans continues to be necessary on site. This approach continues to be the primary way of working on most construction sites even today. Knowledge about the project and processes is retained either in the minds of the skilled persons involved with the construction or on paper, that is on plans or in printed material lists or component descriptions.

BIM enables the entire construction process to be fully digitalised, from the initial concept phase through planning and the construction phase itself to the handover to facility management. Even the demolition of a building can be significantly simplified using BIM as there is considerably more information available on the materials used, for instance. Each stage of the construction process builds on computer-aided information, with

digitalisation therefore encompassing the entire life cycle of the building. BIM software applications preferably support 3D construction, increasingly superseding the 2D methods previously established. It is a fair assumption that two-dimensional construction plans on paper will also become a thing of the past in the near future. Certainly a number of developments are still needed, particularly on the hardware side, but this development can now no longer be stopped.

Today, for example, extensive simulations have become routine methods for determining whether a building is behaving as required in certain situations. Apart from many other benefits, this ensures much more efficient handling of building materials, which, in turn, can also lower construction costs. Digitalisation also enables sub-components to be assembled off-site, for instance through prefabrication, which, in turn can also significantly lower construction costs. This has already been impressively demonstrated by pilot projects supported by Geberit. Cost and time savings amounting to more than 20 % of the total trade figure are therefore a realistic prospect.



Thanks to the extensive information that a BIM object contains, the contractor now knows considerably more about the project in advance than in the past, thanks to the construction model. BIM ensures that all stakeholders involved in the construction have access to all relevant information about the project. The knowledge about the object and processes is therefore integrated into the BIM model and can be accessed at any time. Considerably more efficient construction is therefore possible with BIM.



Figure 4: Today and in the future: 3D BIM model

## 1.2 DEVELOPMENT OF BIM

With the advent of computer-aided planning methods, computer models were programmed in universities in the 1970s, which combined the geometric and alphanumeric data of a building somewhat like a BIM model. However, this was still being done on a more or less experimental level and could not be translated into practice due to a lack of appropriate hardware and software.

The phrase Building Information Modelling (BIM) was mentioned for the first time in the essay "Modelling multiple views on Buildings" by van Nederveen and Tolman published in 1992.

The term BIM and the concept behind it became known to a wider public when Autodesk® published a White Paper in 2002 entitled "Building Information Modeling" and used the term in its marketing strategy. This era also heralds in the development of software applications and data sharing formats and standards.

The use of BIM has been continuously increasing since the 2010s. The public sector, in particular, is introducing BIM into its construction projects or making its use mandatory. The use of BIM has been mandatory in the United Kingdom since 2016 for all public sector construction projects. In Germany, the "Road Map for Digital Design and Construction" published by the Federal Ministry for Transport and Digital Infrastructure sets out the introduction of BIM by 2020. However, it is worth noting in this

context that the development of BIM is driven very strongly by national initiatives, which makes the development of internationally recognised norms and standards more difficult. There was a rethink by politicians, standards institutes and professional bodies and industry associations a short time ago. Representatives of these organisations are now meeting more regularly to share ideas and set out the basis for standards. Nonetheless, BIM continues to be a more or less national matter, resulting in a host of different national norms and standards.

Studies conducted on the use of BIM predict that the BIM method of digital construction will develop to become the future standard method in the execution of complex construction projects.

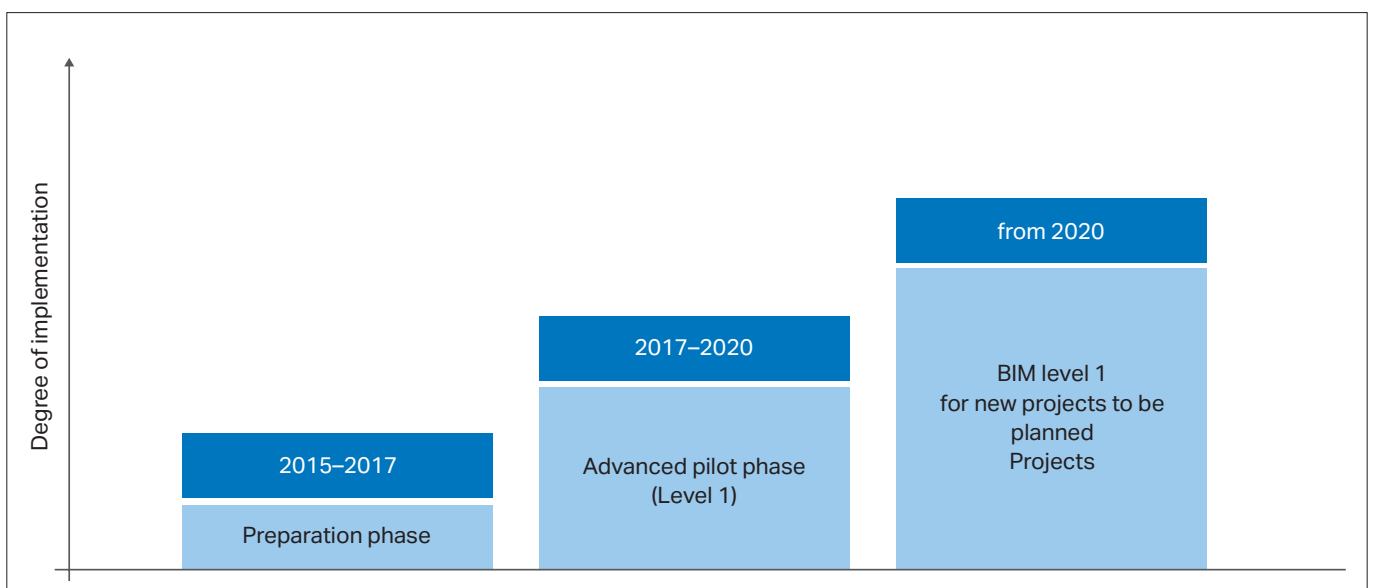

Figure 5: "Road Map for Digital Design and Construction" published by the Federal Ministry for Transport and Digital Infrastructure

CHAPTER TWO

# PRINCIPLES



## 2.1 BIM

### 2.1.1 Definition

BIM is the State-of-the-Art method for planning, building, operating and maintaining buildings on the basis of digital data.

BIM is not software as such, but rather a methodology based on integrated digital construction concepts. Planning a building using planning software therefore does not necessarily mean that it is a BIM project. BIM involves far more than an isolated view of a phase in the life cycle of a building or a focus on the planning of a building using a computer and software.

BIM looks at the complete life cycle of a building from planning to demolition. It considerably simplifies the transfer of information between the different phases in the life of a building. This simplification is not to be underestimated, as information transfer is crucial especially during the construction phase. The possibility of the process-controlled, standardised transfer of information to subcontractor interfaces and throughout the different construction phases, enables efficiency on site to be improved on an unprecedented scale.

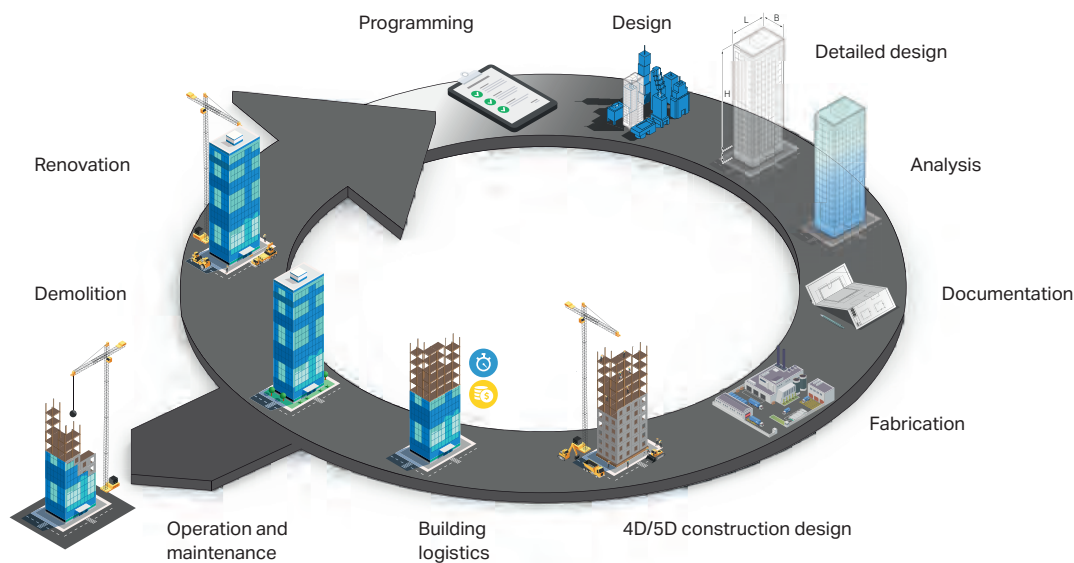

BIM is an acronym and stands for Building Information Modelling. The letters of the acronym have the following meaning:

<b>B</b>	<b>Building</b>	Specifies the area of applicability. BIM applies to the planning, construction and operation of buildings.
<b>I</b>	<b>Information</b>	Indicates the content. The model includes geometric and alphanumeric information on a building, such as the material and diameter of a drinking water pipe.
<b>M</b>	<b>Modelling</b>	Indicates the manner and method. "Modelling" relates to the act of generating a model for a building. The BIM model is a dynamic, virtual 3D model that maps out the life cycle of a building.

### 2.1.2 Dimensions of BIM

Apart from the individual life cycles of a building, BIM also includes all the services that occur within it. The entire traditional construction process can be mapped out using BIM.

Of course, certain aspects of BIM are not yet really well developed while others are more clearly defined: but fundamentally, BIM takes into account all aspects of the construction.

### 2.1.3 The BIM process

The BIM process clearly differs from a traditional construction process. The BIM process leads to a forward shift of planning and decision-making processes with the aim of achieving cost and planning certainty at the earliest possible time. There is therefore a certain amount of additional work needed at the start of a project compared to a traditional construction process, but this then results in significant cost and time savings, as cost-relevant changes or problem areas can be identified during the planning phase. Hence, the cost of so-called 'additions' can be significantly reduced or, ideally, avoided entirely. Delays caused by subsequent adjustments on site can also be considerably reduced or avoided entirely.

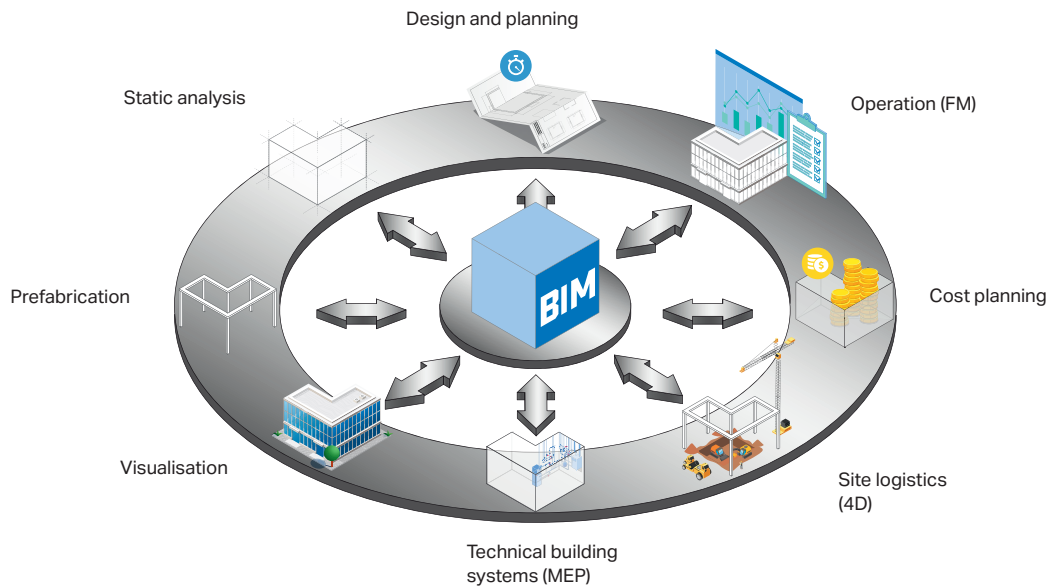

Figure 6: Dimensions of BIM

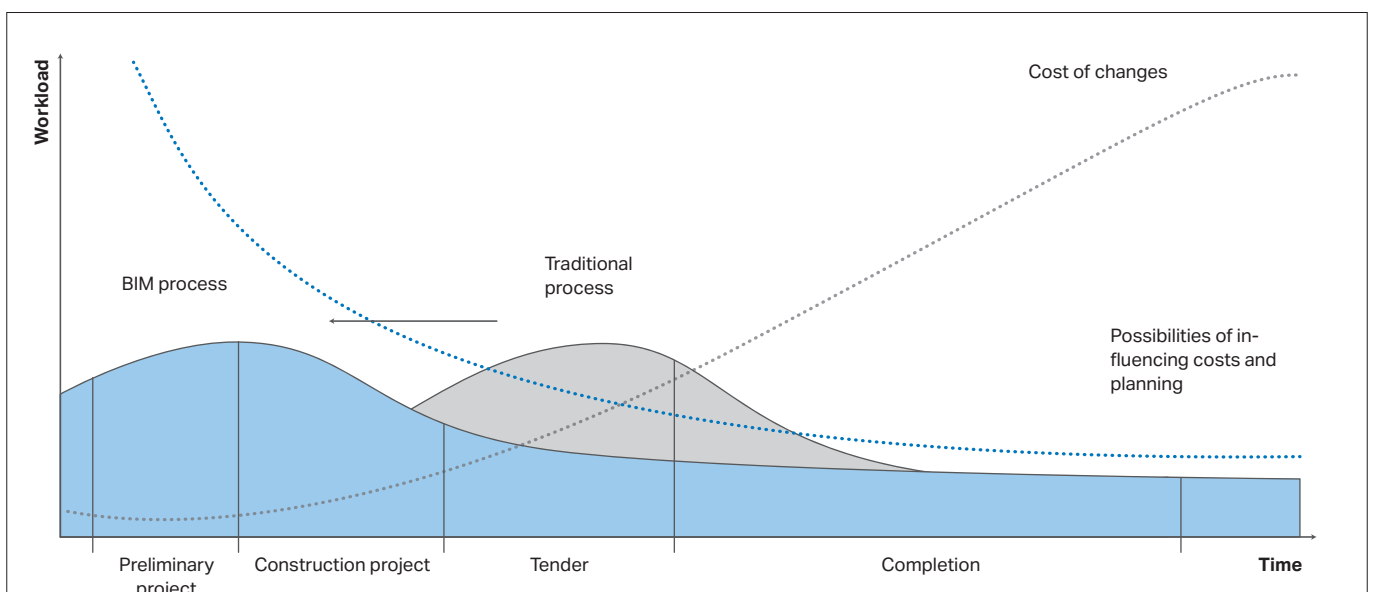

Figure 7: BIM process versus traditional construction process

### 2.1.4 Elements

A number of diverse technical terms are used when working with BIM, two of which are frequently confused with each other: the **BIM model** and the **BIM object**. The **building or integrated model**, at various times also referred to as the **federated model** or **coordination model**, is at the very heart of BIM. The integrated model is generally developed by the architect. In practice, the **discipline models** of the technical disciplines involved on the build are derived from the integrated model.

The building model consists of many individual components, such as walls, ceilings or even the roof construction. The building model also includes many other components from suppliers, such as windows, doors or even sanitary appliances, pipes and cisterns. These components are known as BIM objects. Rather like a construction kit, which consists of individual building blocks, a BIM model consists of many individual components of the building itself and the BIM objects.

The BIM objects do not just have geometric dimensions, as in traditional construction plans, but are also enhanced by comprehensive metadata, which, among other things, includes technical data and information about the material or physical properties. A BIM model contains all the information needed throughout the entire life cycle of a building, from development planning to operation.



Figure 8: Illustration of the BIM model as a 3D construction kit made up of building blocks

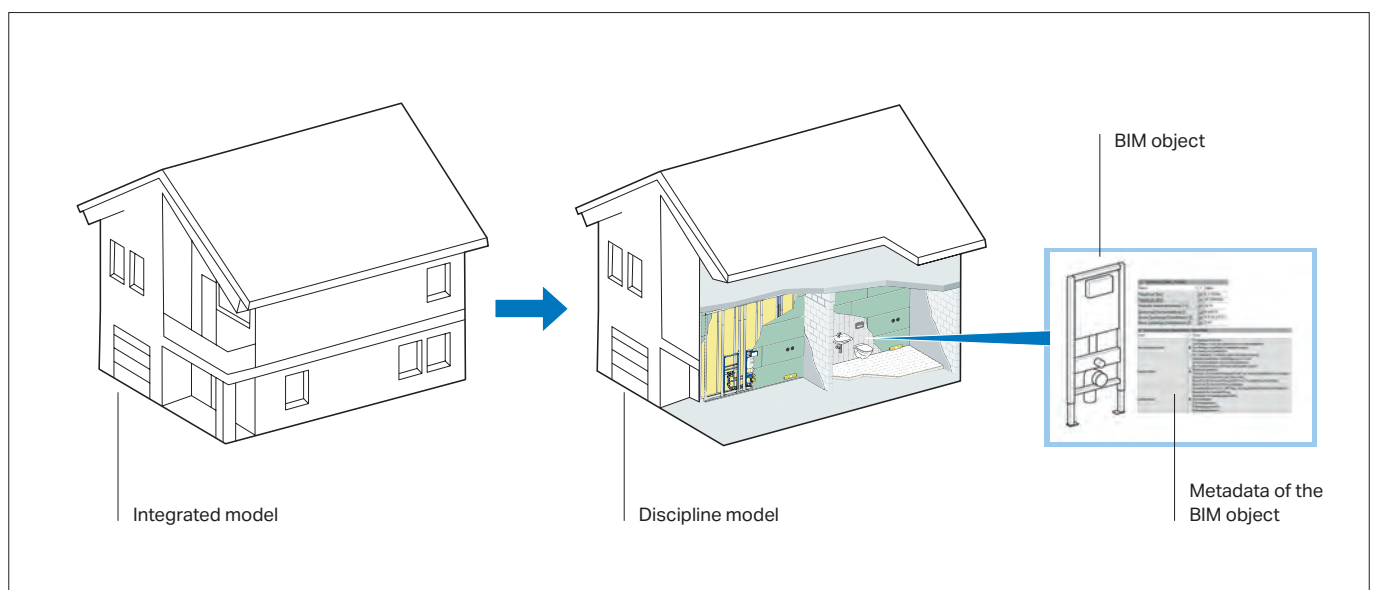

Figure 9: Elements of a BIM model

### 2.1.5 Purpose

Major construction projects are characterised by their increasing technical and organisational complexity. A large number of technical disciplines are needed to meet the construction, design, cost-efficiency and ecological requirements necessary to construct such a building. Information can be lost in the traditional approach with printed or partially digitalised construction plans, separate cost and material lists, leading to breaks in the flow of information occurring time and time again throughout the entire life cycle. In the worst case, the plans no longer correspond to the built state on completion of the building, making maintenance or operation of the building more difficult.

Due to the comprehensive and seamless application of digital technologies, BIM makes complexity transparent and predictable. Interfaces can be managed much better and problems in information transfer avoided. It therefore meets the essential requirements governing modern construction processes, which

can only be met to a limited extent with traditional methods of working:

- precise and cost-intensive control of the construction process
- intensive and efficient sharing of information between all stakeholders, among other things by improving the depth of information and end-to-end change management
- minimisation of risks, such as planning errors, unexpected cost increases during the construction phase caused by additions due to inadequately coordinated planning or excessive operating costs

BIM ensures that large and/or complex construction projects can be completed in the required quality and within the specified time and cost framework.

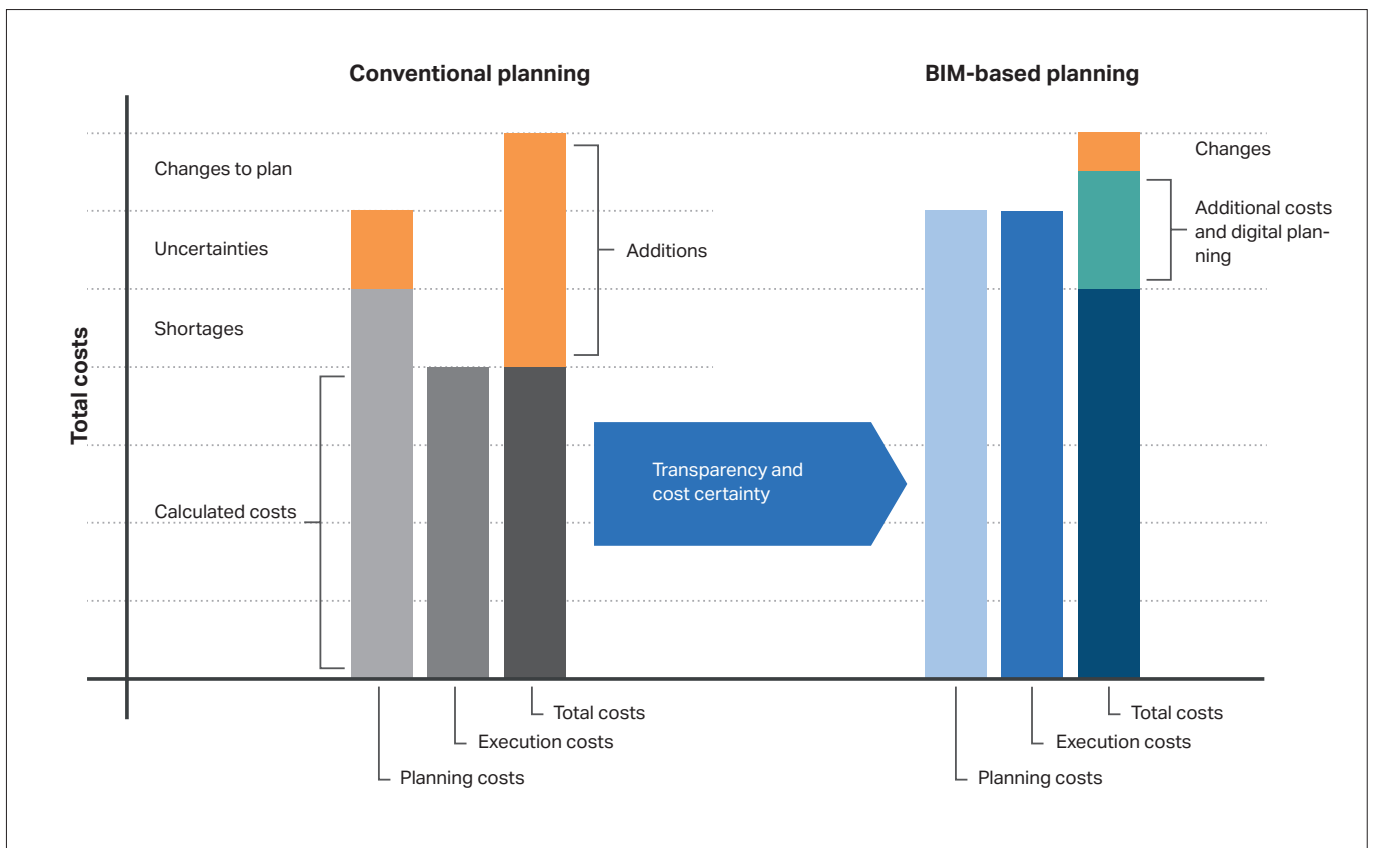

Figure 10: Impact of BIM on the construction costs

### 2.1.6 Benefits

The depth of information of the BIM model coupled with the participation of all project stakeholders in the model results in a transparent, internally dovetailed construction process. Such a process offers a host of benefits:

- use of the latest and accurate product information
- lower procurement cost of product information
- efficient communication between the building owner and project stakeholders based on daily updated information
- partially automated modelling of technical installations by BIM software in conjunction with manufacturer-generated BIM objects
- integrated creation of parts and material lists
- increased process transparency throughout the planning and construction phase
- increased cost transparency, even during the usage phase of a building

- increased cost certainty by reducing or preventing any resulting follow-up work
- reduced planning errors due to IT-supported collision and conformity checks
- reduced overall costs by the use of modern processes, including the prefabrication of components or structural parts
- efficient site management
- efficient logistics and efficient use of construction material

Overall, the above individual benefits lead to cost savings and shorter construction times if BIM is systematically applied end-to-end. It is true that higher costs can occur during the preparatory and planning phase, but they can generally be recouped over the construction period.



## 2.2 THE BIM MODEL

### 2.2.1 Definition of a model

Models occur in a variety of forms in science and technology, such as mathematical models, climate models or models of physical bodies. What they all have in common is the fact that they reflect, represent or simulate reality. Models are used to visualise aspects of reality by reducing their complexity to an understandable level. Models are therefore abstractions of reality. They fulfil a defined function for a limited period of time.

There is evidence of construction models dating back to ancient times. During the Renaissance period, the construction model developed into a scaled simplified model of the building, which was used for design and communication purposes. People have therefore been working with models in the construction sector

for some time. From this perspective, a BIM model is really nothing fundamentally new. It simply shifts the existence of the model from the analogue to the digital sphere, with all the associated benefits. With one exception: a BIM model portrays the physical building in much greater detail than was the case in conventional models.



Figure 11: Visualisation of the BIM model of an office building (without the outer skin)

### 2.2.2 Features

A BIM model is a digital representation of a real building. Unlike a physical architectural model or a construction plan, a BIM model provides a much higher level of detail. Interestingly, the higher level of detail is not based on the fact that the BIM model is a digital model. A digital model can also be designed in such a way that it contains no more information than a construction plan. The crucial difference lies in the data structure and the information content of the BIM model.

Conventional construction plans produced in CAD programs, like their analogue predecessors produced on drawing boards, only use geometric forms. Only a person who understands the meaning of the symbol knows that a quadrant represents a door in the top view perspective. It is also dependent on the knowledge of the skilled person whether the door is placed at a suitable position in the building. The CAD program allows the user to place the door at any position, even an absurd position. The intelligence needed to plan the door professionally lies with the skilled person responsible for the planning. This person selects the right door to meet the requirements and fit the constructional situation based on their education and experience, and by consulting data sheets.

By contrast, in the BIM model, this knowledge is largely integrated as information in the form of data sets. In addition to geometric data, every element also includes alphanumerical data in an attribute structure. A door is not just a quadrant in a BIM model: it is an element in the "Door" class, which includes features characteristic for its class, such as the material or the radius of the door.

Elements, such as doors, walls or washbasins, are known as model elements or BIM objects. The BIM objects form the building blocks of the BIM model. From the perspective of the objects, a BIM model is a representation of a building consisting of valid combinations of BIM objects. The alphanumerical attributes of the BIM objects determine which BIM objects can be combined. If, for instance, a branch is planned in a drinking water pipe in the technical building systems, the software used to create the BIM model automatically inserts a T-piece with the correct dimension. However, it is worth noting at this point that this wide range of functions can only be exploited in specific planning tools.

### 2.2.3 Central model versus federated model

In an ideal world, all project stakeholders would be working on a central BIM model, which is updated in real time, so that every stakeholder always has access to the updated status. However, closer analysis has revealed the concept of a central BIM model to be impractical and inefficient. From an IT perspective, a central model would result in an immense file size, which would push computers and software to their limits. Apart from exceeding the technical limitations, there continue to be questions about access rights and the required depth of information: In a central model, how can you ensure that individual areas, such as struc-

tural planning, can only be edited by the relevant project stakeholders? Conversely, is it useful for structural planners to learn about every change in the model, even if the change is irrelevant for his department? And how could an update process, such as this, be set up?

These were the reasons for largely moving away from the idea of a central BIM model. Instead, a federated model is favoured, which is compiled by the BIM Manager for coordination purposes.

*“The once popular concept of a central BIM model – to which all project parties have access and which is updated in real time – is now considered to be impractical and inefficient. Apart from the sluggishness of a massive central model (as the single location of all project data), the central BIM model generates a series of complications regarding authorship and shared file access. How is it possible to define and control working areas, for example, if all project parties have access to the same model elements? Would all project parties particularly like to see the regular updates that their colleagues make during their iterative design or coordination process? [...] The preferred structure is now the federated model, in which every project party is the sole author of their model elements, and ‘frozen’ sharing models are generated at agreed time intervals to enable colleagues to receive the latest reference information.”*

[Baldwin – Strategies for Virtual Building Services Coordination: page 5, translated back from the original English]

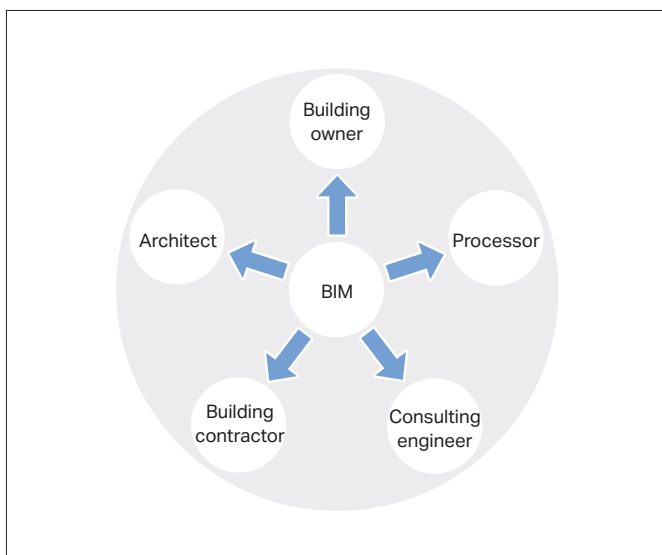

Figure 12: Central model

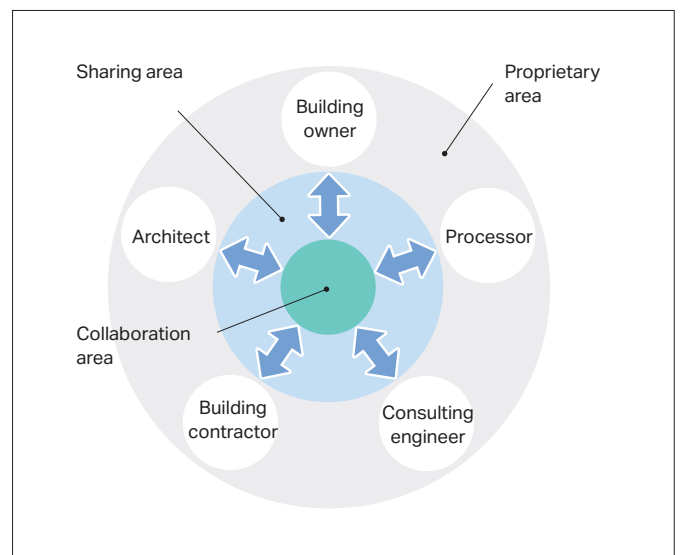

Figure 13: Federated model

### 2.2.4 Reference model and discipline models

A federated model needs to ensure that the discipline models are based on the same coordinates and the same orientation to avoid basic planning and coordination errors. The architectural model generally serves as the basis for this. The common zero point is defined on the basis of a specified coordinate from the architectural model. It is essential that this coordinate is carried over into **all discipline models**.

The individual discipline models, in which the respective trades involved on the build are planned, are coordinated using what is known as a coordination model. The coordination model brings together all the discipline models, among other things, to identify potential collisions between the individual technical plans at an early stage. However, only the discipline models are edited – the coordination model only maps a frozen status at time x. In practice, the consulting engineers involved in the construction and the responsible BIM Manager on the building owner’s side generally define a time by which the consulting engineers have to submit an updated discipline model to the BIM Manager or BIM Coordinator (depending on the organisation of the project), e.g. every 2 weeks.

The HVAC and MEP models (**M**echanical, **E**lectrical and **P**lumbing – also including **H**eating, **V**entilation and **A**ir **C**onditioning) are also summarised under the umbrella heading MEP models.

The coordination model, or more generally the coordination and cooperative aspect of BIM, creates two areas within the BIM model. The one area is the consolidated coordination model, which visualises the so-called **As-built status**, provided all changes or adjustments have been systematically carried out and incorporated in the model. The other area is formed by the previous discipline models, which depict the planning status, the so-called **As-planned status**. It is essential that the As-built model is updated at the shortest possible intervals. If this is neglected, after a certain point in time there will no longer be agreement between the As-planned status and the actual As-built status of the building.

An integrated model, such as this, is almost worthless for the downstream life cycles of the building, such as the operation, and it would take a great deal of time to adapt it to the real As-built status of the building. This is then done using laser scanning or photogrammetry, among other things, i.e. the entire building is scanned or photographed using special tools and this data is then combined in a model. This process is complex and time-consuming, as every room needs to be scanned individually. There also need to be flights with drones to record the outer skin of the building. It goes without saying that this process is extremely expensive. From the cost alone, it is therefore crucial to “keep the coordination model alive”. Every consulting engineer is urged to record every change, no matter how small, in his discipline model and to ensure that the changes are incorporated in the coordination model after a predefined coordination process (providing they have been approved by the site management). Every consulting engineer is responsible for the accuracy of his discipline model – with responsibilities clearly demarcated.

In reality, often so-called general planners are contracted to provide the general planning to have as few interfaces as possible in the planning and construction process. Interface management between the trades involved presents one of the biggest challenges in BIM.

The fundamental difference between CAD drawings and BIM models becomes clear at this point. CAD sharing formats, such as IGES or DWG (2D and 3D), are concerned with transferring the content of drawings between different native CAD programs. In the provision of BIM models, the sharing format (such as IFC 2.3) needs to be capable of transferring object data, which also includes geometric data as a sub-group. The demands placed on BIM sharing formats are therefore significantly more complex.

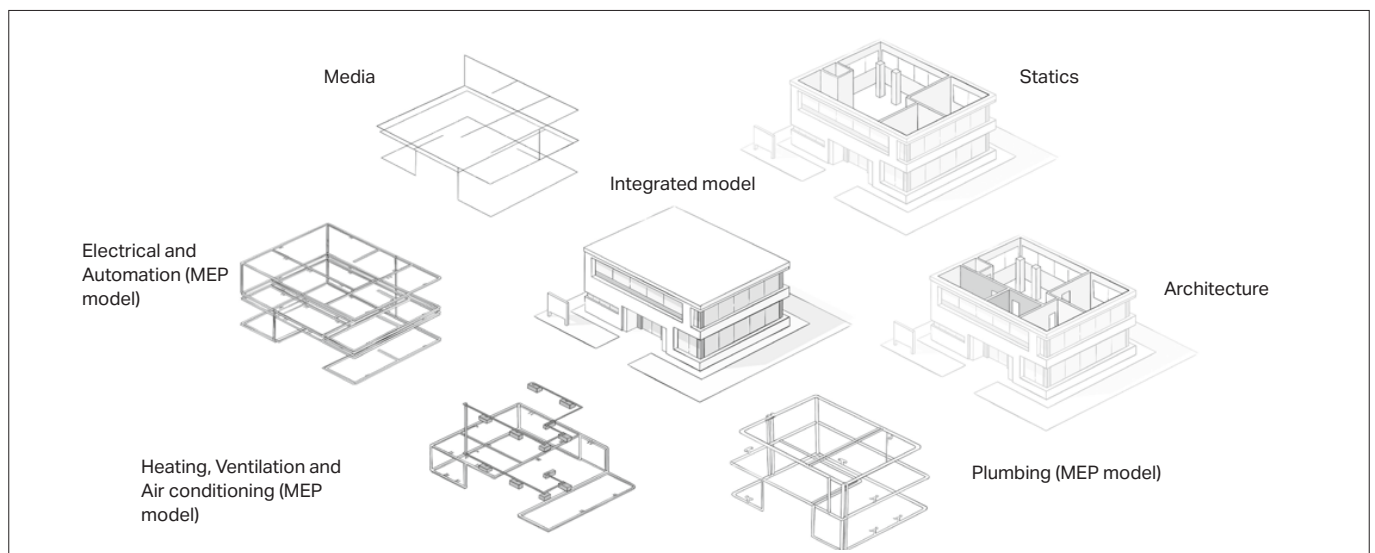

### 2.2.5 Open BIM versus closed BIM

The sharing format is crucial in the federated model. The use of a basic model on which the discipline models are based, and a coordination model, which combines the discipline models, requires the model data to be capable of being shared between the different models. Sharing formats are available as proprietary or open models.

Closed BIM denotes a BIM process in which the discipline models' data is shared on the basis of a proprietary format. The proprietary format is based on a software manufacturer's information model, which was not made known. Accordingly, data sharing necessitates that all project stakeholders work with the same manufacturer's BIM software e.g. Autodesk® Revit®.

Open BIM denotes a BIM process in which the discipline models' data is shared on the basis of an open format. The information model on which the format is based is known. The project stakeholders can use different manufacturers' BIM software in the open BIM process. It is only necessary to ensure that the software is compatible with the open format selected. When considered more comprehensively, open BIM opens up the possibility of an open data format becoming a sharing standard, ensuring that BIM content can be shared and integrated across the system.

Open BIM is based on the idea of the reference model. The architect makes his model available write-protected in an open BIM format. The MEP planner, for instance, saves his planning in his own model with a write-protected reference to the architectural model and plans his networks on the basis of the data supplied. The MEP planner can, in turn, export his MEP model to the open format, possibly to make it available for project coordination in a coordination model.

IFC (Industry Foundation Classes) is the most widely used open sharing format in the development of BIM. However, IFC cannot yet be regarded as a comprehensive sharing format. For instance, there are no relevant attribute classes for mechanical, electrical and plumbing objects, which would be needed to calculate supply networks and waste water prefabrication, something that is extremely helpful with the planning of piping systems.

So much for the theory. In practice, almost all projects created using BIM are managed as closed BIM projects, i.e. either the building owner specifies the software to be used in advance or stakeholders agree during the preliminary project management phase on the software to be used. The seamless progress of a BIM project is practically only possible in a proprietary format, particularly with MEP trades, as the various software applications can either share no data or only a limited amount of data with each other. As the development of the IFC class model is not yet available for all MEP trades, the only option is to use native formats when data is shared.

The Geberit Group is seriously committed to the standardisation of data models and is actively involved in a BTGA working group in Frankfurt am Main. The aim of the initiative is the classification, typing and creation of all the technical attributes of MEP trades in a common nomenclature. Part 9 of VDI 2552 currently serves as the platform for this. There is also a cooperation in this context with buildingSMART, which has the same objective. All features of technical building objects are to be brought together in Part 9 of VDI 2552, to create a data model that enables sharing between proprietary and native systems for the first time in the history of BIM.

At the moment, data sharing between native systems is still not working seamlessly, as inevitably not every user or generator of BIM content (predominantly the construction products industry) describes the properties of its products in the same way due to the absence of a common standard. This even causes problems when sharing data between native systems, e.g. from Revit® to Revit®. How is this supposed to work in an open BIM environment between different manufacturers' software applications? The receiving system is essentially reliant on a clearly defined common data model if it is to clearly recognise and correctly interpret incoming parameters. Refer also in this context to the chapter Standards.

## 2.3 THE BIM OBJECT

### 2.3.1 Features

BIM objects are the elementary building blocks of a BIM model. From the perspective of object-orientated programming, a BIM object represents the instance of a class of objects within a BIM model. Every class of objects is defined by a specific set of attributes. The attributes assume specific values in a BIM object.

In the same way that the BIM model represents a virtual representation of the physical building, BIM objects represent the physical construction elements of which a building is composed. They include all the data with which a BIM object is recognised as a specific component and behave in the same way as the physical original. For example, specific attributes can be used to model the fact that the BIM object can be positioned in the same way as the physical original.

The object classes must continue to take into account the fact that BIM objects can be linked to each other like their physical originals. An installation element for a WC also needs to have a water supply connection in the BIM model, by means of which it can be connected to the drinking water pipe. BIM object data is therefore configured in such a way that the relationships between construction elements can also be visualised.

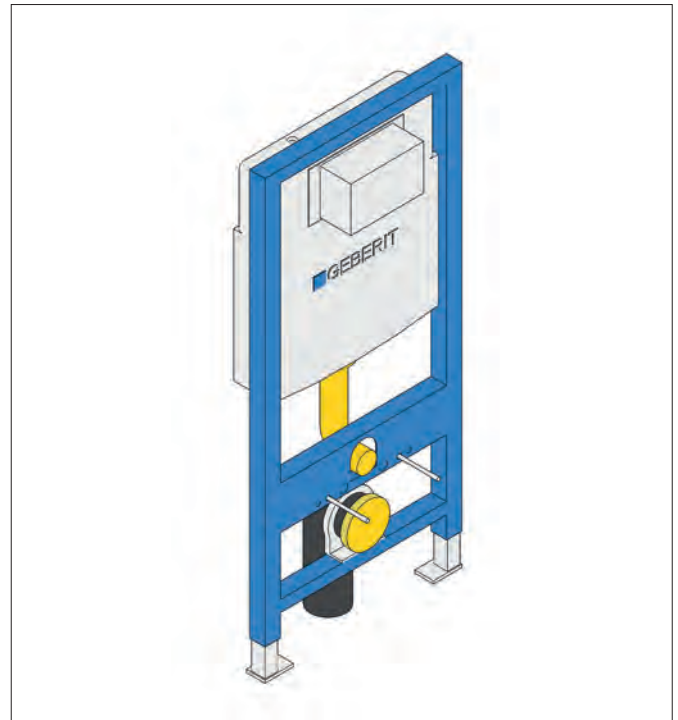

Figure 14: Example of a BIM object

***“BIM objects include geometric and alphanumeric information that can be related to each other and analysed in the BIM model, for example to produce parts lists. A BIM object should therefore be capable of incorporating all the information needed to design, find, specify and analyse the component.”***

[<https://www.baunetzwissen.de/bim/fachwissen/modellinhalte/was-ist-ein-bim-objekt-5292455>, accessed on 17.01.2019]

### 2.3.2 Level of detail (LOD)

Every planning phase of a building is characterised by a specific need for information. Only the approximate size, position and orientation of a BIM object and its basic properties, such as “load-bearing / non-load-bearing” are needed in the design planning. By contrast, the BIM object needs to be enhanced with additional information for execution planning. The MEP planner, for instance, needs to know the material of a construction element as well as the dimensions he should expect. And in the construction phase, the stakeholders need to be able to access detailed manufacturer-specific information.

To meet the need for information at the different service phases and applications, BIM objects have different levels of detail, known as LOD. The level of detail relates to the geometric and alphanumeric information. The levels of detail of these two sub-aspects are known as the level of geometry (LOG) and level of information (LOI). The LOD therefore consists of:

$$LOD = LOG + LOI$$

The LOD provides for 6 levels of detail, from low (100) to high (500). The higher the LOD, the more geometric and alphanumeric information the BIM object contains.

The following table illustrates the LODs 200, 300 and 400 and shows how they relate to the respective service phases.

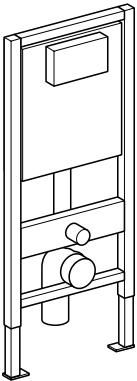
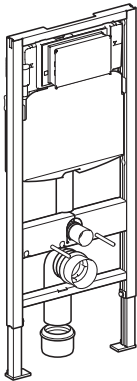
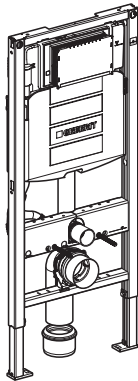
LOD 200	LOD 300	LOD 400
		
Design planning	Factory planning	Construction/in- stallation

By defining the level of detail, BIM objects of the same class can be quickly and efficiently compared to each other by BIM authors.

So much for the theory. Often only minor importance is attached to the LOD in practice. In general, the stakeholders on a project agree on a common LOD (generally LOD 300/400) at the start of the project, which - based on the geometry of the BIM objects - remains static throughout the entire project. Who would want to share planned BIM objects for a more detailed version from construction phase to construction phase? The additional work resulting from this would lead to immense additional costs. What is more, detailed geometries required bigger files, which can push hardware and software close to their performance limits, particularly in large projects. The detailing of the geometry is therefore of minor importance in relation to manufacturer’s data, but the information content is thus all the more important.

In the integrated model and also in the discipline models, the LOD is, of course, continuous, as the level of detail is continuously increasing from basic evaluation to execution planning. In this respect, the file sizes of the BIM objects play a vital role, as the more detailed the planning, the more BIM objects are planned in the models. The number of BIM objects therefore has a significant impact on the performance of the integrated model and the discipline models. Frequently, consulting engineers create their own BIM objects in proprietary BIM libraries, as manufacturer’s data is too difficult and of poor quality to handle. Refer also in this respect to “BIM content – practical problems”, page 78.

### 2.3.3 Generic versus manufacturer-specific

Two types of BIM objects can be derived from the LOD: generic BIM objects and manufacturer-specific BIM objects.

A “manufacturer-neutral” and minimally specified BIM object is referred to as being generic. It is therefore not or not yet enhanced with information from a specific manufacturer or a sales product. Generic BIM objects are also designated as library objects, as they can be inserted from the BIM software object library and used as a placeholder for specification at a later phase.

By contrast, manufacturer-specific BIM objects already carry the information of a specific sales product. The need for manufacturer-specific BIM objects generally arises in the transition from design planning to execution planning, but, at the latest, when tendering for services to obtain comparable quotations.

By definition, a manufacturer-specific BIM object always has a higher LOD than a generic BIM object.

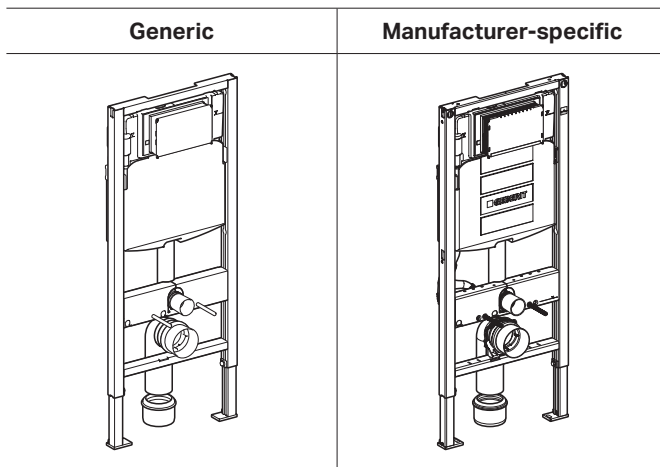

There tends to be a more pragmatic approach in practice. To avoid the time-consuming adaptation of the planned BIM objects during the transition from design planning to execution, very often users define at the design planning phase the products to be used in the project.

The BIM objects therefore only need to be planned once in the discipline models and do not need to be updated when a trade contract is awarded. This approach offers significant potential savings in planning, particularly in large projects in the private sector and enables a binding cost estimate to be arrived at earlier. The timing of the decision about which products are to be used in a project occurs earlier in a BIM project than with previous or conventional construction processes.

This approach is not usually permitted in public sector projects. A manufacturer-neutral tender for all construction services is generally called for in public sector projects. This consequently leads to additional planning work as the BIM objects to be installed only become known when the service contract is awarded and hence can only be finally defined at the execution planning phase. A rethink is also slowly starting to take place here, as this approach is not very effective and leads to additional costs, as the manufacturer-neutral BIM objects in the discipline models need to be replaced by manufacturer-specific BIM objects. A further problem is the availability of manufacturer-neutral BIM objects as they are generally created by construction product manufacturers and provided to consulting engineers. If they are provided at all, as only very few manufacturers provide BIM objects in generic form. Refer in this respect also to "Manufacturer-neutral tenders", page 81.

### 2.3.4 Data sharing

The open and collaborative approach of BIM only really comes into its own when sharing can also be guaranteed on the data format front. Open and platform-independent formats are being developed in national and international bodies to meet this need. The Industry Foundation Classes (IFC), part of the buildingSMART initiative, represents the best-known and most widely used format. Admittedly the latest version of IFC is capable of transferring a large volume of information but not in a fully editable logic for the "receiving system".

***"The IFC format developed by buildingSMART, with which a model can be transferred to other software programs, is able to transport the geometry and other standardised parameters, but an editable air guide network does not reach the destination system. [...] For this reason, the receiving system cannot transfer the data in its editable logic with the IFC format and, in the best case, "only" depicts the geometry. Sole solution: the contractors procure the same software that the sanitary engineers have used. We then find ourselves in a closed BIM system."***

[Hoffeller – Die BIM-Welt braucht endlich Ordnung (The BIM world finally needs order), in: Bauprodukte digital, April 2018 edition, page 9]



### 2.3.5 Data formats

The possible data formats throughout a BIM process are as varied as the specialist disciplines working on the BIM model in the individual phases of the building's life cycle. Every specialist discipline has its own proprietary BIM software. Different tools and data formats are used within a specialist discipline, such as MEP planning:

- AutoCAD MEP
- Revit® MEP
- AECOsim Building Designer
- Plancal nova
- MagiCAD
- liNear

To name but a few.

The variety of data formats during the BIM process presents the challenge of nonetheless being able to share information between the various discipline models. This is only possible with proprietary file formats if the same platform is used to create the discipline models – nonetheless with the consequence that the open character of BIM is “closed off” from at least a technical point of view. Users who use another software need to transfer the model to their platform, which generally means recreating the model.

***“That then brings us to the next problem: this process only works if the sanitary engineers and contractors are working with the same software. When the model needs to be transferred from one software platform to another, at the moment there’s no way around redrawing it. In spite of all the innovation that BIM promises, this fundamental finding is essentially the lowest common denominator.”***

[Hoffeller – Die BIM-Welt braucht endlich Ordnung (The BIM world finally needs order), in: Bauprodukte digital, April 2018 edition, page 8/9]

## 2.4 BIM IN THE CONSTRUCTION INDUSTRY

### 2.4.1 Status

#### Level of use

A study by the Fraunhofer Institute for Industrial Engineering showed that currently 29% of companies in the construction industry in Germany use BIM as a planning and coordination method (Roland Berger – Digitalisierung in der Bauwirtschaft (Digitalisation in the Construction Industry): 2016, page 13). It is evident that the use of BIM decreases along the value-added chain. While architects and sanitary engineers already work to a large degree with BIM, it is only minimally used by contractors.

Apart from architects and sanitary engineers, it is manufacturers of construction products, above all, who intensively work with BIM. However, it is a rather diverse picture even amongst the manufacturers. There are manufacturers who already have a comprehensive digital strategy compared to others who have very little involvement with digital construction.

*“The penetration of BIM differs considerably between the individual groups within the HVAC industry and falls off along the value-added chain. [...] 46 % of manufacturers, 37 % of architects and approx. 5 % of HVAC craftspeople are working with BIM today.”*

[ZVSHK, Munich Strategy – SHK-Branche im BIM-Check (HVAC Industry in the BIM Check): 2018, page 5]

*“At the moment there is a very uneven picture of the individual changes to BIM and any adaptations resulting from this. For instance, there are manufacturers who have a comprehensive BIM strategy as part of their higher-level, clearly implemented digitalisation strategy, whereas there are other companies whose supposedly good response merely rests with laboriously generated BIM content sets.”*

[Wieselhuber & Partner – BIM – are you ready: 2018, page 7]

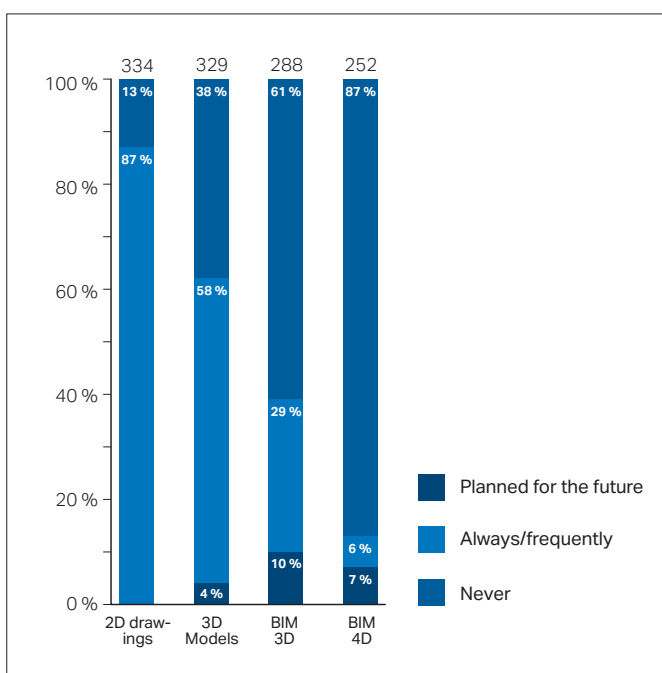

Figure 15: Use of planning methods in the construction industry (Source: Roland Berger: 2016, according to the Fraunhofer Institute)

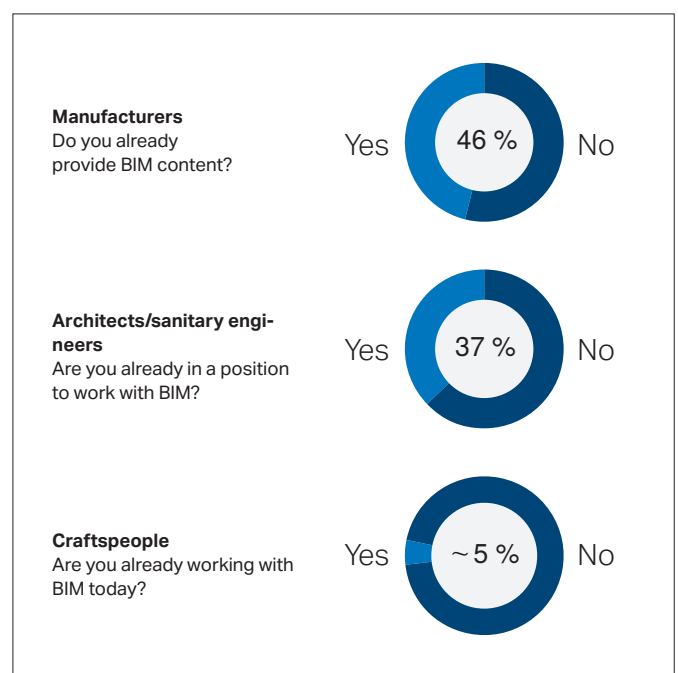

Figure 16: Penetration of BIM according to the ZVSHK, Munich Strategy: 2018

### Maturity levels

Wieselhuber & Partner have incorporated the maturity level as a measuring variable in their study to measure to what extent stakeholders in the construction industry have already implemented BIM. The maturity level consists of 6 dimensions.

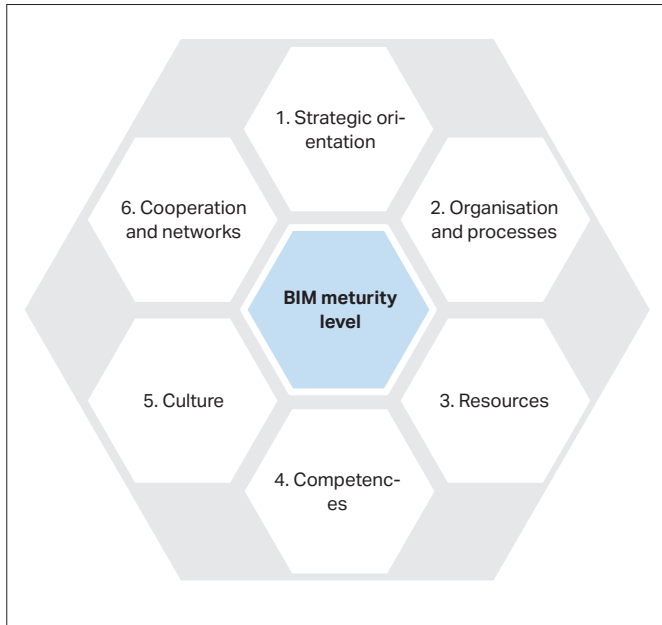

Figure 17: Dimensions of the BIM maturity level according to Wieselhuber & Partner

Companies who have already widely implemented BIM are designated as “strong strategists” and are far advanced in terms of the 6 dimensions of BIM maturity level [Wieselhuber & Partner: BIM – Are you ready: 2018, page 34]:

- systematic consideration of BIM in the strategy
- active alignment according to the new/changed role in the value-added chain in the six design dimensions
- extremely systematic adaptation of organisation, processes, competences and resources
- networks and cooperation partners are specifically selected according to BIM competences
- already winning many projects through BIM competence
- already achieving comprehensive efficiency benefits from BIM

Architects, consulting engineers and the manufacturers of construction products are among the “strong strategists”. The study regards the latter as the future drivers of BIM, as the larger companies, in particular, have the requisite resources combined with the knowledge and penetration power to fundamentally advance BIM.

### Impact

BIM will lead to fundamental changes in the construction industry. The consulting firm Roland Berger assumes the following changes based on a survey of senior management of construction companies and the construction industry (Roland Berger – Digitalisierung in der Bauwirtschaft (Digitalisation in the Construction Industry): 2016):

- shift of decision-making structures
- competitive advantages through the use of BIM
- increased demands on information management due to the proliferation of product data

The selection and procurement of construction products is one example of the shift in decision-making structures. Whereas up to now the construction contractor or the contracted trades have selected and procured the construction products from a certain manufacturer, the use of BIM will make it possible to integrate detailed construction products into the building models at the planning phase. The decision about a construction product therefore shifts from the construction company to the architect and sanitary engineer.

This will give companies who have integrated BIM into their organisation a competitive edge by the very fact alone that the public sector is driving forward the use of BIM. In Germany, for example, the Federal Ministry for Transport and Infrastructure has presented its Road Map for Digital Construction, which provides for the introduction of BIM by 2020.

The demands on information management are rising significantly due to the volume of data produced and managed in a BIM model. The distribution of BIM manufacturer’s data is also crucial in addition to the coordination of the discipline models. Manufacturers of construction products who know how to implement a coherent product information system based on data consistency and customer needs will benefit in this process.

**“products for bim” manufacturers’ initiative**

In 2017, well-known manufacturers of construction products teamed up to set up the “products for bim” manufacturers’ initiative to visibly help shape the development from a traditional construction process to BIM. The Geberit Group has been an active member of the initiative since the start of 2019. The initiative is convinced that the digital services of construction product manufacturers will make an important contribution to maximising the full potential of BIM.

Their objectives include the following key aspects:

- design of digital product data and services to meet practical needs
- sharing of information and experiences from day-to-day business life
- opportunities for modern networking between manufacturers and customers
- expansion of digital value-added chains within companies

The manufacturers’ initiative has also launched the Digital Construction Association under the auspices of the Professional Association of Construction Systems to drive forward the digitalisation of the construction industry institutionally as well. The companies organised within the professional association are distinguished by the fact that they:

- actively support the further development of the BIM process.
- work jointly and openly with partners and customers on practical solutions to implement a BIM approach in everyday working life.
- act as contacts for customers to discuss and solve questions and problems relating to BIM and digitalisation on a level playing field.
- are open to new ideas and technologies and associated requirements.

***“The aim of the initiative is to ensure the practical implementation of digital manufacturer’s information to advance digital processes for sanitary engineers, processors, product manufacturers and operators of buildings.”***

[[www.productsforbim.com](http://www.productsforbim.com), accessed on 17.01.2019]

## 2.4.2 Challenges for construction product manufacturers

### The changing role of the construction product manufacturer

To date, the manufacturers of construction products have only been involved in the planning and construction of buildings in individual cases. The sanitary engineer would contact the construction product manufacturer's consultant if he had specific questions about the planning requirements or positioning options of a construction product. If this was not the case, the sanitary engineer would plan the construction product and the installer would install the product without the manufacturer being involved in this process.

BIM significantly changes the role of the construction product manufacturer in the planning, construction and maintenance process of a building. He therefore essentially becomes part of the planning and construction process as the digital form of his products, used as BIM objects, represent the basic building blocks of the BIM model. The role of the manufacturer consists of producing the most up-to-date and accurate data for his products in the form of BIM objects throughout the entire life cycle of a building. The most important phase in this process is the planning phase, during which the BIM objects are inserted into the BIM model by the sanitary engineer. The manufacturer can also provide additional information, such as technical documentation or information about spare parts, or even services, for instance to calculate supply networks, through the digital BIM object. The role of the manufacturer will therefore change in future from being a pure supplier of construction products to becoming a construction and service partner.

### Data management

#### Complexity

More and more manufacturers of construction products are providing BIM objects to download. Many manufacturers are creating their BIM objects in-house, while others are using external service providers for this. The BIM objects created are then made available in various data formats on the subsidiaries' local websites or on online hosting platforms.

From a data management point of view, these approaches, which differ very little from each other, present fundamental disadvantages: they are expensive, time-consuming, resource-intensive and, ultimately, present largely static objects.

Global companies are faced with a complex challenge, further massively complicated by static objects. After all, if you pursue the approach of producing static objects, then all different models of every single product relevant for planning would have to be produced as BIM objects, as well as the local derivatives in

the local language. In practice, this would result in a vast number of data sets based on the Geberit product range.

An obvious strategy for combatting the complexity of data lies in simplifying the dimensions, that is to say reducing the complexity. Depending on the data format and/or software, it is possible to combine models into parametrised families and so reduce the number of geometric models to be created. However, this does not entirely solve the problem.

A further method would be to reduce the language dimension by using English to avoid multilingualism. However, this approach has the disadvantage that it does not accommodate all users. Often metadata entries in the BIM objects need to be abbreviated due to system-based circumstances. At the latest at this stage, the "English version" is of little use to anyone who has no or only very little English, as cryptic abbreviations of component names cannot be translated with the use of a dictionary.

Refer in this respect also to "BIM Herstellerdaten – Theorie und Praxis" (BIM Manufacturers' Data - Theory and Practice) by Werner Trefzer, BIM Manager of the Geberit Group, which appeared in "Bauprodukte digital", April 2018 edition.

#### Validity of BIM objects

Apart from the multidimensionality of the data on which the BIM objects are based, the question about the validity of BIM objects presents an additional dynamic factor. How does an MEP planner actually know whether the BIM object used still corresponds to its physical image?

If the internal workflows, which ensure the uploading and downloading of data onto external web platforms, fail or cannot be scrupulously maintained, then no one can take responsibility for valid BIM objects – not the operator of the platform nor the construction product manufacturer.

You could well imagine the following case in practice: an MEP planner downloads a static BIM object or an entire family from an online platform and uses it in his discipline model. The project is a large project with a design and planning phase lasting several years, with a correspondingly high number of stakeholders involved. The tender phase begins at a certain time, and then the planned products are ordered. However, the manufacturer has now removed product X from his product range, or has changed key characteristics in such a way that the plan needs to be adjusted. In the worst case, the adjustment to the plan will lead to delays in the progress of the project.

Even today, the question is still not legally clarified as to who is ultimately responsible for these delays. Without a doubt, a case such as this could result in legal disputes.

**Single-source approach**

The multidimensionality of BIM object data and its validity presents manufacturers of construction products with major challenges in terms of data logic. At first glance, it might appear as if an additional data channel would need to be open and kept up-to-date to provide BIM objects, which would go hand in hand with a massive workload and costs associated with the large volume of data.

The product range and data of the BIM objects need to be up-to-date and apply to all markets in which the manufacturer offers his products. However, this point of view, that is a standardised data design in multiple languages and based on locally different product ranges, would be hard to implement from a data and process perspective.

On closer inspection, BIM offers an opportunity for the manufacturer of construction products to systematically rely on a single-source approach and further expand it. Every manufacturer keeps data on his construction products for logistical, legal and distribution reasons.

Pre-sales publications, such as printed and digital product catalogues, present an important distribution element. The product data for these publications is generally administered and maintained in product information systems (PIM systems). This leads to the logical step that the data for the BIM objects also originates from this source. Seen from this perspective, BIM objects represent an extension of the product information system.

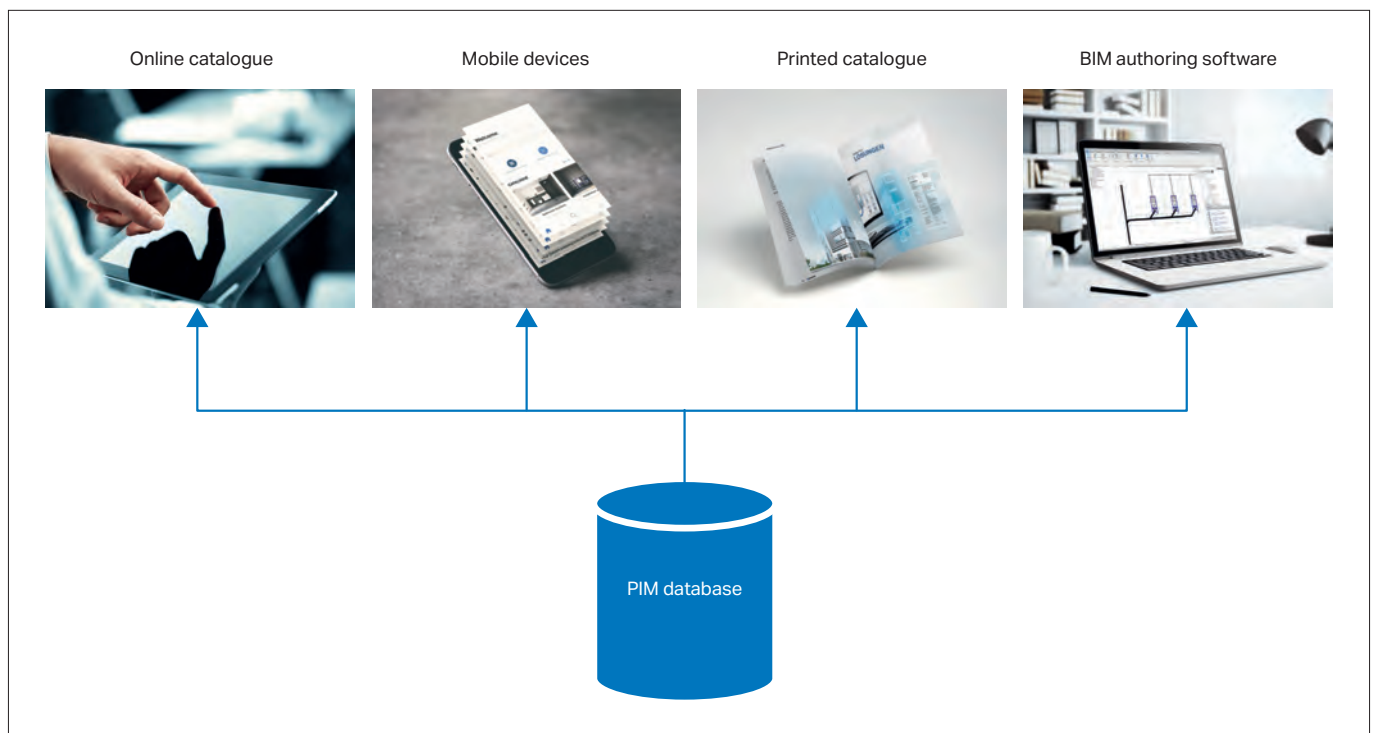

Figure 18: PIM system as a data source for BIM objects

## Data distribution

### User-orientated LOD

Depending on the technical group and planning phase, the requirements governing the depth of information of a BIM object, the level of detail, range from very low to very high.

In terms of the level of detail of geometric data (level of geometry), an MEP planner can generally cope with a very simple geometry restricted to the essential characteristics of a product. Depending on whether he also wishes to use the data for visualisation purposes, the architect may have other requirements under certain circumstances. BIM objects with a detailed geometry quickly end up with file sizes that run into megabytes. Particularly with more extensive projects, this leads to the BIM model consisting of these objects, becoming so large that it pushes the performance of computers and software to their limits. From this perspective, it is advisable for the construction product manufacturer to rely on the simplest possible geometries.

The case is somewhat different with alphanumeric data (metadata). Every construction phase demands specific information in the model. While the architect can cope with very little information during the design phase, facility managers ask for a different information content to be able to carry out the maintenance and repair of an object as efficiently as possible.

Logically seen, static BIM objects have three options for dealing with this situation:

- The BIM object has a maximum of metadata.
- The BIM object has a minimum of metadata.
- The BIM object has different levels of information coordinated to the individual construction phases.

All three options are considered to be unsatisfactory. Architects and MEP planners are just as unhappy about option 1 as contracting trades, as a maximum of metadata tends to be more of a hindrance for them for various reasons. In principle, option 2 means that all disciplines need to enhance the BIM object themselves with metadata to meet their need for information – which also goes hand in hand with additional work. Option 3 equates to the introduction of an additional unwanted multiplier in the reproduction of BIM objects. It also leads to BIM objects in the BIM model having to be replaced depending on the level of detail – which, among other things, would result in the loss of the object references, depending on the software used.

Considering the LODs from the manufacturer’s point of view shows that there is not yet a really conclusive “update concept”, which can grow with the LOD of a BIM object throughout the different construction phases. The most suitable solution at the moment consists of combining the best of the three options. You start with the maximum content of information, which could be gradually released throughout the construction phases. A solution, such as this, would be feasible without major technical software-based work. Undoubtedly all stakeholders involved in the construction, including manufacturers, will go their own way until there is a common approach to this question.

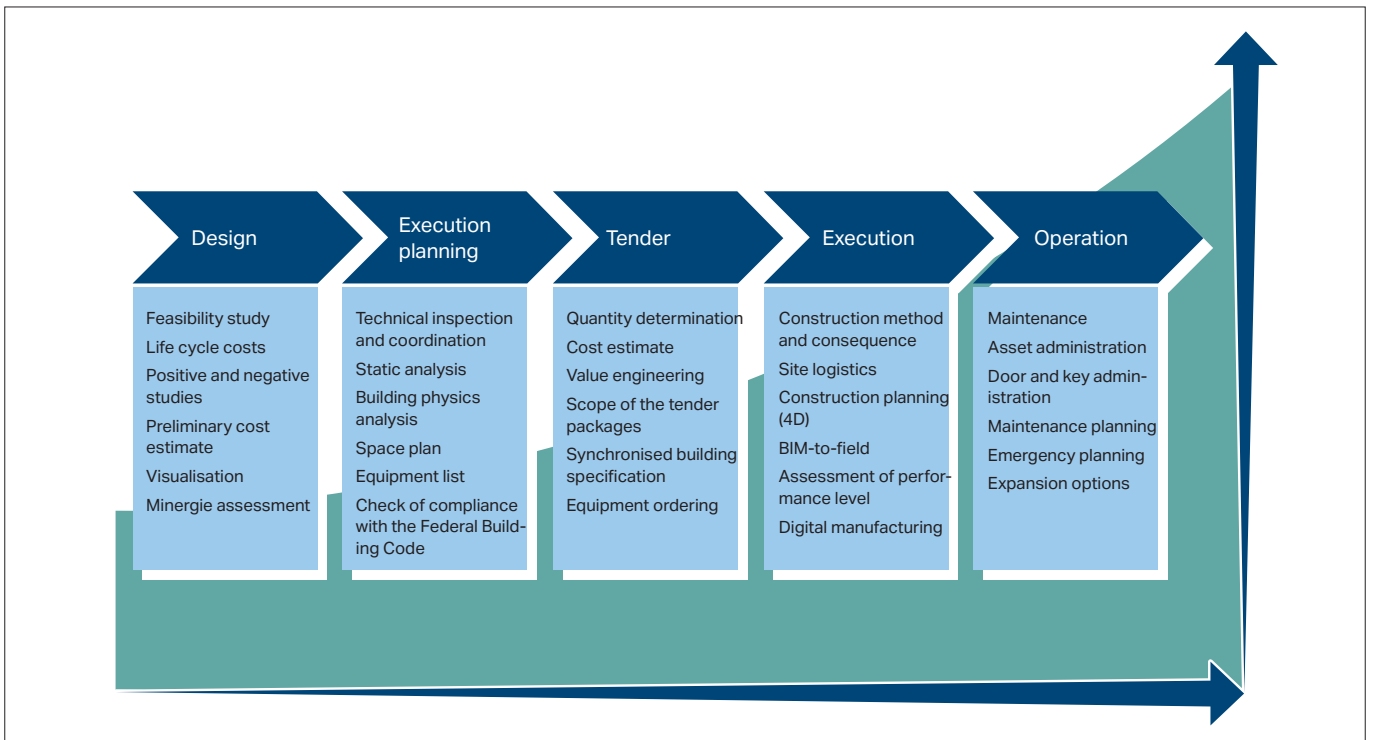

Figure 19: Increased metadata (LOI) during the course of the project

**Data configuration**

The configuration and data format of the BIM object need to be compatible with the sanitary engineer's digital tools for creating and editing BIM models. As there are different tools available on the market, the manufacturer is essentially faced with the challenge of making available his BIM objects in a configuration that can be read by all common tools. The data format therefore represents an additional factor in the proliferation of BIM objects.

Despite many initiatives to simplify it, the BIM world essentially consists of a jumble of software systems, data formats, data standards, online platforms and concepts of all kinds. Manufacturers stand in the middle of all the "solutions" offered, asking themselves how to overcome this challenge. The BIM world is still far from agreeing on a common data standard, which would permit data sharing between proprietary software systems. Admittedly the IFC format of the buildingSMART initiative represents such a standard but is not currently in a position to transfer MEP networks in a fully editable form from one proprietary BIM authoring system to the next.

**Source and channels**

Once a company has found the way to create BIM objects, it then needs to consider how to transfer its BIM objects to the customer. At this stage, every company needs to pursue its own philosophy. The fact that a customer can download and use BIM models from different manufacturers via a well-placed platform x is a major plus point for platforms. That is undisputedly simpler

than having to visit possibly three or four manufacturer's websites and acquire BIM objects there. However, from a manufacturer's point of view, this also involves disadvantages, such as, for instance, the loss of data sovereignty, a possible lack of feedback about download numbers etc. The update process might also be considerably more time-consuming than on a company's own website.

It is undisputed that serious manual data management is practically impossible with large and locally different product ranges and different languages. How is a company supposed to maintain and update thousands of different data sets with a manageable number of employees? But with dozens of Internet platforms and hosting providers for BIM objects, the issue of manual data handling is doomed to failure from the outset. There need to be other solutions and they need to be found in the automated transmission of BIM objects, bypassing third-party solutions.

The disadvantages can be avoided by integrating the manufacturer's own PIM system into the process and importing the metadata from the PIM system into the BIM software. Were this to work, it would be possible to effortlessly update the data with minimal work using a cloud-based web service. To do this, all that would be necessary would be to program a corresponding plug-in. This would enable service providers to be connected to the internal PIM systems and therefore massively simplify the process of generating BIM objects. This would make exports, imports and queries almost obsolete.



CHAPTER THREE

# STANDARDS AND GUIDELINES



## 3.1 OVERVIEW

Building Information Modelling describes processes for digital collaboration and communication in the construction industry. Common regulations and semantics are therefore fundamental prerequisites for successful digital cooperation.

Companies, associations and bodies at different levels worldwide are dedicating themselves to standardising BIM. The international harmonisation of standards and norms is intended to facilitate global cooperation in multinational projects and hence minimise the current problems of digital cooperation. Bodies have been set up to consider BIM within the ISO, CEN, DIN and also VDI standards organisations. The following table provides an overview of the different organisations and areas of application.

The current status of BIM guidelines and standards is largely based on the work of the buildingSMART initiative, its local asso-

ciations in over 30 countries and numerous regional groups. Probably the best-known result of their work is the definition, development and certification of the IFC file format. At the same time, many other associations, such as the VDI with its VDI BIM coordination group or the CAFM group, have been carrying out important standardisation work for many years.

However, the development is by far not completed, which explains why we can only provide a snapshot at this stage about this very agile issue with no guarantee of completeness.

Organisation	Type	Area of application
User, office, company (littleBIM)	Office standard	Internal
Project group with multiple stakeholders (bigBIM)	AIA <sup>1)</sup> , BAP <sup>2)</sup> , CAD guidelines	Local to international
Associations, societies (buildingSMART, VDI, CAFM-Connect)	Guidelines, specifications	Local to international
German Institute for Standardisation (DIN)	Standard (DIN, DIN EN, DIN ISO, DIN EN ISO), Draft standards (Suffix "E" or "Draft", Specifications (Suffix "SPEC")	Local (Germany)
Austrian Standards International (A.S.I.)	Standard (ÖNORM, ÖNORM EN, ÖNORM ISO, ÖNORM EN ISO)	Local (Austria)
Swiss Society of Engineers and Architects (SIA)	Standard (SN, SN EN, SN ISO, SN EN ISO) Guideline (SIA code of practice)	Local (Switzerland)
European Committee for Standardisation (CEN)	Standard (EN) Project (Suffix "pr")	European
International Organisation for Standardisation (ISO)	Standard (ISO) Draft (DIS)	International

<sup>1)</sup> Client request for information

<sup>2)</sup> BIM execution plan

## 3.2 INTERNATIONAL STANDARDS

### 3.2.1 Overview

The following norms define BIM standards on an international level:

- ISO 19650 "Organisation of information about buildings – Information management using building information modelling (BIM)"
- ISO 16379 "Industry Foundation Classes (IFC) for data sharing in the construction and facility management industries"
- ISO 29481 "Building information models – Information delivery manual"
- ISO 16757 "Data structures for electronic product catalogues for building services equipment"
- ISO 12006 "Building construction – Organisation of information about construction works"
- ISO/DIS 23386 "Building information modelling and other digital processes used in construction – Methodology to describe, author and maintain properties in interconnected data dictionaries"
- BS 1192

### 3.2.2 ISO 19650

ISO 19650 "Organisation of information about buildings – Information management using building information modelling (BIM)" deals with information management throughout the entire life cycle of a building and describes methods for the flow of information in BIM projects. The standard defines principles of information management, which are supplemented at a country level by national appendices. The British specification PAS 1192 and the British standard BS 1192 formed the basis of ISO 19650.

ISO 19650 consists of two parts.

Part 1 "Concepts and principles" defines concepts, including information models, information requirement and information services and assigns these concepts to different management levels. Part 1 also includes requirements regulating the sharing of information and the BIM execution plan (BAP), defined as the continuously updated basis of information sharing. Demands for a common data environment (CDE), which serves as the basis for secured data sharing, concludes part 1.

Part 2 "Delivery phase of the assets" describes the processes of planning and construction within different phases of the project. The processes present recommendations as an exemplary procedure (Best Practice), as the demand for full implementation would not be expedient particularly with small projects.

ISO 19650 has been implemented in the following national standards in the German-speaking world:

- Germany: DIN EN ISO 19650-1:2017-04 – Draft, DIN EN ISO 19650-1:2018-04 – Draft

### 3.2.3 ISO 16739

ISO 16379 "Industry Foundation Classes (IFC) for data sharing in the construction and facility management industries" describes the IFC data scheme and model, which enables data sharing in BIM projects.

The IFC format is developed by the buildingSMART initiative and includes semantics, geometry and relations to describe buildings and components.

There are different versions of the IFC format available up to IFC 4. Version IFC 2x3 is currently used and certified for many software products. IFC 4.1 and IFC 5 are under preparation and will include classes for roads, bridges, railways and tunnels. The modelling language used is EXPRESS. The geometric description of the objects is based on the STEP format.

Version ISO 16739-1:2018 of the standard is currently available and has been implemented in the following national standards in the German-speaking world:

- Germany: DIN EN ISO 16739:2017
- Switzerland: SN EN ISO 16739:2016

### 3.2.4 ISO 29481

ISO 29481 "Building information models (BIM) – Information delivery manual" describes methods for promoting collaboration between different stakeholders in the construction process and creating a basis for error-free, reliable, replicable and high-quality information sharing.

ISO 19650 consists of two parts.

Part 1 "Methodology and format" describes a methodology linking the business processes undertaken during the construction of built facilities to the specification of information required by these processes. Part 1 also shows a way of mapping and describing the information processes throughout the life cycle of a building. Finally, it presents approaches for creating information manuals (Information Delivery Manuals, IDM) and implementing them in a format that can be read by computer programs. The aim of part 1 is to facilitate the interoperability of software applications used during all phases of the life cycle of a building.

Part 2 "Interaction Framework" specifies a methodology that permits coordination between all stakeholders involved in a construction project. The methodology consists of:

- a method that describes an interaction framework
- a method for mapping responsibilities and interactions in the process context
- a format for specifying the interaction framework

ISO 29481 is implemented in the following standards on a European level and in the German-speaking world:

- Europe: EN ISO 29481-1:2017, EN ISO 29481-2:2016
- Germany: DIN EN ISO 29481-1:2018, DIN EN ISO 29481-2:2017
- Austria: ÖNORM EN ISO 29481-1:2018, ÖNORM EN ISO 29481-2:2017
- Switzerland: SN EN ISO 29481-1:2017 (SIA 440.001:2017), SN EN ISO 29481-2:2016 (SIA 440.002:2016)

### 3.2.5 ISO 16757

ISO 16757 “Data structures for electronic product catalogues for building services” is still in preparation. The standard is intended to internationalise the standards described in VDI guideline 3805 to describe MEP components and thereby define electronic product data sharing on an international level. It has the following detailed aims:

- To map the entire product data sharing in the plumbing, heating, ventilation and air conditioning sectors.
- To make manufacturer’s data available directly to the user via the relevant software programs.
- To facilitate the software-based search and selection of products and their direct transfer to different authoring systems.

Product features are defined in accordance with the data model set out in ISO 13584 “Industrial automation systems and integration”.

ISO 16757 is planned as a four-part series of standards. Parts 1 to 5 define the principles for the sharing of product data. The descriptions of product-specific data and its sharing formats will follow from part 10 onwards.

Parts 1 and 2 have already been published. Work on part 10 and the subsequent parts will only start once basic parts 1 to 5 have been written.

The basic parts 1 to 5 are structured as follows:

- Part 1 “Concepts, architecture and models” describes the concept of the series of standards, as well as the data architecture and data model.
- Part 2 “Geometry” describes the visualisation of the geometry.
- Part 3 will deal with the possible programming languages and functions.
- Part 4 will deal with the relationship between ISO 16757 and other BIM standards.
- Part 5 will define the sharing format for the product data.

ISO 16757 has been implemented in the following national standards in the German-speaking world:

- Germany: DIN ISO 16757-1:2015, DIN ISO 16757-1:2015
- Austria: ÖNORM EN ISO 16757-1:2018 – Draft, ÖNORM EN ISO 16757-2:2018 – Draft

There is no link between the similarly sounding DIN EN 16757 “Sustainability of construction works – Environmental product declarations – Product category rules for concrete and concrete elements”.

### 3.2.6 ISO 12006

ISO 12006 “Building construction – Organisation of information about construction works” describes the possibilities for organising and structuring information sharing in BIM processes. Parts 2 and 3 of the standard are available.

Part 2 “Structure for the classification of information” defines the framework for the classification of information and provides examples of this.

Part 3 “Framework for object-orientated information sharing” defines the framework for object-orientated information sharing based on a language-independent information model. This framework can be used to develop dictionaries and to store or provide information on buildings. It provides for reference to classification systems, data models, object models and process models within a common framework. Part 3 forms the basis of the buildingSMART Data Dictionary (bSDD).

Versions ISO 12006-2:2015 and ISO 12006-3:2007 of the standard are currently available and have been implemented into the following standards in the German-speaking world:

- Germany: DIN EN ISO 12006-3:2017
- Austria: ÖNORM EN ISO 12006-3:2017
- Switzerland: SN EN ISO 12006-3:2016 (SIA 440.110)

### 3.2.7 ISO 23386

ISO/DIS 23386 “Building information modelling and other digital processes used in construction – Methodology to describe, author and maintain properties in interconnected data dictionaries” is currently being drafted (DIS = Draft International).

The standard regulates the rules to define features and their attributes, and attributes for the creation and maintenance of enquiries. It also defines roles for experts and a model for control (governance model) by establishing a steering committee. And lastly, it contains management roles for linking data catalogues.

The objective of ISO/DIS 23386 is to define the features used in the construction industry and to determine a method for creating and maintaining these features to facilitate reliable and problem-free data sharing.

The standard is currently available as a draft ISO/DIS 23386:2019. The following drafts are available on a European level and in the German-speaking world:

- Europe: European project prEN ISO 23386:2019
- Germany: DIN EN ISO 23386:2019 – Draft
- Austria: ÖNORM EN ISO 23386:2019-02-15 – Draft

### 3.2.8 BS 1192

The first version BS 1192-5:1990 of the British standard BS 1192 published in 1990 deals with methods for the standardisation of the information flow in the construction industry and can therefore be regarded as the mother of all BIM standards.

BS 1192 describes a method for the creation and distribution of construction information and its quality assurance. It takes into account the use of CAD and BIM authoring systems by defining a strict process for cooperation and specific naming conventions.

In addition to the standard, different specifications have also appeared as PAS 1192 (Publicly Available Specification). The specifications deal with specific applications, for instance project standards for tenders, tender award and operation, and contain instructions for optimum procedures (Best Practice) and templates for contracts, protocols (CPIx) etc.

The last version BS 1192:2007 of the standard and the specification PAS 1192-2 were replaced in 2018 by the nationally implemented international standard BS EN ISO 19650.

## 3.3 LOCAL STANDARDS

More and more construction firms and sanitary engineers are operating across national borders as a result of continued globalisation and due to EU regulations governing the award of public sector tenders. A harmonised interpretation of the standard by ISO, CEN and regional standards bodies is sought to simplify cross-border cooperation for building owners, sanitary engineers and contractors.

On the other hand, country-specific characteristics and legal provisions also need to be considered for the issuing of standards. Nationally implemented ISO or EN standards, which are also designated as mirrored standards, are the result of this process.

Local standards continue to exist in addition to the mirrored standards for which there is no international equivalent.

### 3.3.1 Germany

#### Mirrored standards

The following mirrored standards apply to the BIM sector in Germany:

- DIN EN ISO 19650-1:2017-04 – Draft “Organisation of information about buildings – Information management using building information modelling – Concepts and principles”
- DIN EN ISO 19650-1:2018-04 – Draft “Organisation of information about buildings – Information management using building information modelling – Delivery phase of the assets”

- DIN EN ISO 16739:2017 “Industry Foundation Classes (IFC) for data sharing in the construction and facility management industries”<sup>1)</sup>
- DIN EN ISO 29481-1:2018 “Building information models (BIM) – Information delivery manual – Methodology and format”
- DIN EN ISO 29481-2:2017 “Building information models (BIM) – Information delivery manual – Interaction Framework”
- DIN ISO 16757-1:2015 – Draft “Data structures for electronic product catalogues for building services – Part 1: Concepts, architecture and models”
- DIN EN ISO 16757-2:2018 – Draft “Data structures for electronic product catalogues for building services – Part 2: Geometry”
- DIN EN ISO 12006-3:2017 “Building construction – Organisation of information about construction works”
- DIN EN ISO 23386:2019 – Draft “Building information modelling and other digital processes used in construction – Methodology to describe, author and maintain properties in interconnected data dictionaries”

<sup>1)</sup> The German standard was created by mirroring ISO 16379:2013. The latest ISO 16379:2018 standard has not yet been mirrored.

**DIN EN 17412**

DIN EN 17412:2019 – Draft “Building Information Modelling – BIM definition levels” is currently being drafted and is based on the European project prEN 17412:2019.

The draft standard describes a methodology with which the level of detail of BIM models can be defined. The definitions define the scope of information which BIM models need to have with regard to the relevant BIM applications. It continues to make available clear terminology to qualify and describe BIM objects and building models and demonstrates a general route for giving the various levels of details a unique nomenclature.

**3.3.2 Austria****Mirrored standards**

The following mirrored standards apply to the BIM sector in Austria:

- ÖNORM EN ISO 29481-1:2018 “Building information models (BIM) – Information delivery manual – Methodology and format”
- ÖNORM EN ISO 29481-2:2017 “Building information models (BIM) – Information delivery manual – Interaction Framework”
- ÖNORM ISO 16757-1:2018 – Draft “Data structures for electronic product catalogues for building services – Part 1: Concepts, architecture and models”
- ÖNORM EN ISO 16757-2:2018-11 – Draft “Data structures for electronic product catalogues for building services – Part 2: Geometry”
- ÖNORM EN ISO 12006-3:2017 “Building construction – Organisation of information about construction works”
- ÖNORM EN ISO 23386:2019 – Draft “Building information modelling and other digital processes used in construction – Methodology to describe, author and maintain properties in interconnected data dictionaries”

**ÖNORM A 6241**

ÖNORM A 6241 “Digital building modelling” consists of two parts. The first part ÖNORM A 6241-1 is regarded as a successor to ÖNORM A 6240-4. This was expanded with execution and detailed planning and will remove any vagueness. The second part ÖNORM A 6241-2 includes the prerequisites to reach BIM level 3. The standard has various appendices, which contain useful templates and directories.

Part 1: “CAD data structures and Building Information Modelling (BIM) – Level 2” regulates the technical implementation of data sharing and the data management of building information for building constructions and related, space-forming underground constructions. This considers the entire life cycle from planning to facility management. It sets out the key concepts, structures and visualisation principles for working with CAD files and BIM projects.

Part 2 “Building Information Modelling (BIM) – Level 3 iBIM” regulates the technical implementation of a standardised, structured and multidimensional data model for buildings and related, space-forming underground constructions. It includes principles for the comprehensive, standardised, product-neutral and systematic sharing of geometric data and alphanumeric data based on IFC (Industrial Foundation Classes) and bSDD (buildingSMART Data Dictionary).

**3.3.3 Switzerland****Mirrored standards**

The following mirrored standards apply to the BIM sector in Switzerland:

- SN EN ISO 16739:2016 (SIA 440.001:2016) “Industry Foundation Classes (IFC) for data sharing in the construction and facility management industries” (Footnote: The Swiss standard was created by mirroring ISO 16379:2013. The latest ISO 16379:2018 standard has not yet been mirrored.)
- SN EN ISO 29481-1:2017 (SIA 440.001:2017) “Building information models (BIM) – Information delivery manual – Methodology and format”
- SN EN ISO 29481-2:2017 (SIA 440.002:2016) “Building information models (BIM) – Information delivery manual – Interaction Framework”
- SN EN ISO 12006-3:2017 (SIA 440.110) “Building construction – Organisation of information about construction works”

**SIA 2501**

The code of practice SIA 2501 “Building Information Modelling (BIM) – Principles for the use of BIM” is regarded as a groundbreaking, generally understandable aid for planning in the digital age. It defines concepts and explains abbreviations, describes the organisation of BIM processes and interdisciplinary cooperation, designates the roles in the BIM process and forms a basis for agreeing performance and remuneration between the project partners.

The code of practice can be compared to the international standard ISO 19650 and largely agrees with it, although the level of detail is higher.

In addition to the code of practice, there are also two documents, which can be used as practical aids:

- Document D 0270 “Application of BIM – A guide to improvement of cooperation”
- Document D 0271 “Application of BIM – Model-based determination of quantity”

## 3.4 GUIDELINES AND SPECIFICATIONS

Unlike standards, guidelines and specifications are generally not published by standards organisations but rather by associations or societies. Accordingly, they do not need to be created by consensus and be accepted by a recognised institution. They often represent the precursors to a standardisation campaign and serve as the basis for consensus-building discussions.

### 3.4.1 VDI 2552

VDI 2552 “Building Information Modeling” is a guideline series published by the German Association of Engineers (VDI). The series of guidelines is probably the best-known and currently the most widely discussed standardisation work on BIM in Germany, Austria and Switzerland. The VDI coordination working group responsible for its creation has been working closely since 2013 with the DIN standards committee responsible for mirroring the international standard to avoid contradictions in the respective standards. Unlike the DIN drafts (e.g. DIN EN ISO 19650), the VDI guidelines presented to date have been positively assessed by the German Chamber of Architects, as they are based more specifically on the national situation and needs.

The objective of VDI 2552 is to create a structured approach for the effective implementation of BIM into planning, construction and operating processes.

The series of guidelines consists of 11 parts including sub-parts on specific issues. The editing status of the individual parts differs greatly. For this reason, not all guidelines are yet available.

Part 1 “Principles” is currently being drafted and is intended to be published in June 2019. The guideline describes the international rules of technology already established, experiences and development in the application of BIM and refers to additional regulations in the subsequent parts of the guideline. It takes into account national and international standards and specifications as well as optimum procedural experiences (Best Practices) and provides, in particular, a reference for the creation and use of building information during the planning and construction of a building or plant.

Part 2 “Concepts” is also in draft form and was published as such in June 2018. The guideline includes BIM concepts in German and English with their respective definition and comments.

Part 3 “Model-based quantity determination for cost planning, scheduling, tender award and billing” was published in May 2018. The guideline describes the application of BIM models including a link to resources and schedules. It presents a method with which the risks can be effectively faced. Among other things, the focus is on determining target and actual values in data form in the calculation of expenditure and services rendered. All project phases from development to completion of a building are considered when comparing performance volumes and controlling structures.

Part 4 “Data sharing requirements” is also in draft form and was published as such in October 2018. The guideline describes data sharing in the application of BIM between the stakeholders involved in the planning, construction and operation of buildings. It considers the initial data for planning work as well as the results data needed for a successful overall BIM process.

Part 5 “Data management” was published in December 2018. The guideline defines procedures for the organisation, structuring, merger, distribution, administration and archiving of digital data within the framework of BIM. It highlights the technical and organisational requirements for the implementation of a common data environment (CDE).

Part 6 “FM” is currently at the project status stage and is set to be published in October 2021. The guideline is intended to describe the BIM structures needed for facility management (FM). This might include, for instance, the recording of operationally-relevant data within planning, support for energy balance sheets, evidence of sustainability as well as the avoidance of information losses when changing to operation.

Part 7 “Processes” is in draft form and was published as such in October 2018. The guideline sets out the principles and tools for a professional BIM process description over the entire life cycle of a building. It describes the methods and BIM-relevant processes and provides examples, showing the connection between the building owner’s information requirements (AIA) and the BIM execution plan (BAP) as well as the information deliveries involved still to be agreed.

VDI/bS-MT 2552 Part 8.1 “Basic knowledge” was published in January 2019. The guideline forms the basis for the buildingSMART and VDI training certificate. It has the objective of ensuring the quality and relevance of BIM basic courses offered by training institutions and defines the minimum knowledge to be imparted for this.

VDI/bS 2552 Part 8.2 “Advanced knowledge” is currently at the project status and is to be published in July 2020. The guideline forms the basis for the buildingSMART and VDI training certificates. One of the main objectives of the guideline is to define the qualifications and guidelines relating to the professional role of a “BIM Manager”.

Part 9 “Classifications” is currently at the project status and is to be published in November 2019. During work on Part 3 “Model-based quantity determination for cost planning, scheduling, tender award and billing” it was established that there are no standardised component descriptions in a BIM context. Part 9 is intended to include these missing component descriptions. The guideline could therefore become an important component of the VDI BIM Manual to which all other VDI BIM guidelines refer.

Part 10 "Building owner's information requirements (AIA) and BIM execution plans (BAP)" are currently at the project status and are to be published in December 2019. AIA and BAP have established themselves with the placing of orders and writing of quotations for BIM projects, although in very different versions. This leads to great uncertainty among stakeholders and also carries considerable risks. The guideline is intended to offer information and advice to stakeholders when it comes to placing orders and writing quotations to help them arrive at practicable solutions. The objective is to adapt the project-specific conditions in such a way that it gives the building owner certainty at the same time as not overwhelming the contractor.

Part 11 "Information sharing requirements" is currently at the project status and is intended to be published in April 2020. The day-to-day sharing of BIM content information has shown that difficulties can often arise when the need for information (Exchange Requirements) is not adequately described. Today's specifications are too general and focus too little on the specific purpose of the information sharing. The guideline is intended to develop methods for defining Exchange Requirements (ER) based on existing BIM content sharing standards, which are feasible in terms of software and provide a basis for technical certification.

Part 11.3 "Information sharing requirements – Formwork and scaffolding technology (on-site concrete construction) is currently at the project stage. A publication date has not yet been announced. The guideline hopes to define the Exchange Requirements (ER) specifically for formwork and scaffolding technology on projects with on-site concrete construction.

### 3.4.2 VDI 3805

VDI 3805 "Product data sharing in the mechanical, electrical and plumbing sectors" is a series of guidelines by the German Association of Engineers (VDI), which has been developed since 1986. The objective of the series of guidelines is to develop standardisation of sharing formats between CAD, BIM and calculation software. A VDI 3805-compliant data set contains both manufacturer-specific, geometric and alphanumeric data, as well as dynamic function and the combinatorics required for the design of the product.

Apart from Part 1 "Principles", the series of guidelines includes around 40 parts, which take into account the specific product characteristics from the heating, ventilation, sanitary and electrical catalogues.

The series of guidelines has been included in the international standard since 2014. The Technical Committee 59 of the ISO (ISO/TC 59 Buildings and civil engineering works) is developing the multi-part standard ISO 16757 "Product Data for Building Services System Model" on the basis of VDI 3805.

Part 1 "Principles" was published in October 2011. The guideline describes principles for product data sharing in computer-aided mechanical, electrical and plumbing planning processes. Among other things, it defines the general product data model, the associated data set structure and the specification of geometric data. A project to revise Part 1 is currently under way. The revised version is set to be published in February 2021.

The following list provides an overview of the additional parts.

- VDI 3805 Part 2:2016-01 "Product data sharing in the mechanical, electrical and plumbing industries – Heating valves"
- VDI 3805 Part 3:2004-06 "Product data sharing in the mechanical, electrical and plumbing industries – Heat generators". In addition, there is also a project for Part 3 – Revision project, which is to be published in January 2021.
- VDI 3805 Part 4:2005-04 "Product data sharing in the mechanical, electrical and plumbing industries – Pumps".
- VDI 3805 Part 4:2018-05 – Draft "Product data sharing in the mechanical, electrical and plumbing industries – Pumps (centrifugal pumps)"
- VDI 3805 Part 5:2007-03 "Product data sharing in the mechanical, electrical and plumbing industries – Diffusers"
- VDI 3805 Part 5:2019-01 – Draft "Product data sharing in the mechanical, electrical and plumbing industries – Diffusers"
- VDI 3805 Part 6:2015-07 "Product data sharing in the mechanical, electrical and plumbing industries – Radiators, heating and cooling convectors, with and without fan"
- VDI 3805 Part 7:2005-07 "Product data sharing in the mechanical, electrical and plumbing industries – Fans"
- VDI 3805 Part 7:2019-04 – Draft "Product data sharing in the mechanical, electrical and plumbing industries – Fans"
- VDI 3805 Part 8:2004-06 "Product data sharing in the mechanical, electrical and plumbing industries – Burners"
- VDI 3805 Part 9:2002-04 "Product data sharing in the mechanical, electrical and plumbing industries – Modular ventilation units". In addition, there is also a project for VDI 3805 Part 9 – Revision project, which is to be published in October 2020.
- VDI 3805 Part 10:2003-07 "Product data sharing in the mechanical, electrical and plumbing industries – Air filters", which was published in July 2003. In addition, there is a project VDI 3805 Part 10 – Revision project, which is to be published in February 2021.
- VDI 3805 Part 11:2003-07 "Product data sharing in the mechanical, electrical and plumbing industries – Fluid/steam heat exchangers – Air"
- VDI 3805 Part 14:2006-08 "Product data sharing in the mechanical, electrical and plumbing industries – Air handling unit silencers (passive)" was published in August 2008. In addition, there is also a project for Part 14 – Revision project, which is to be published in October 2021.
- VDI 3805 Part 16:2003-07 "Product data sharing in the mechanical, electrical and plumbing industries – Fire dampers"
- VDI 3805 Part 16:2018-01 – Draft "Product data sharing in the mechanical, electrical and plumbing industries – Fire dampers/ smoke extraction dampers"



- VDI 3805 Part 17:2016-01 "Product data sharing in the mechanical, electrical and plumbing industries – Valves for drinking water installations"
- VDI 3805 Part 18:2013-09 "Product data sharing in the mechanical, electrical and plumbing industries – Surface heating/cooling"
- VDI 3805 Part 19:2006-02 "Product data sharing in the mechanical, electrical and plumbing industries – Solar collectors". In addition, there is also a project VDI 3805 Part 19 – Revision project, which is to be published in September 2020.
- VDI 3805 Part 20:2017-02 "Product data sharing in the mechanical, electrical and plumbing industries – Tanks and instantaneous water heaters"
- VDI 3805 Part 21:2019-03 "Product data sharing in the mechanical, electrical and plumbing industries – Sanitary installation elements"
- VDI 3805 Part 22:2019-03 "Product data sharing in the mechanical, electrical and plumbing industries – Heat pumps"
- VDI 3805 Part 23:2019-03 "Product data sharing in the mechanical, electrical and plumbing industries – Domestic ventilation equipment"
- VDI 3805 Part 24:2019-04 "Product data sharing in the mechanical, electrical and plumbing industries – Valve actuators for MEP components"
- VDI 3805 Part 25:2011-10 – Draft "Product data sharing in the mechanical, electrical and plumbing industries – Chilled ceiling elements"
- VDI 3805 Part 26:2018-10 "Product data sharing in the mechanical, electrical and plumbing industries – Combined heat and power (CHP)"
- VDI 3805 Part 29:2013-08 "Product data sharing in the mechanical, electrical and plumbing industries – Pipes and fittings"
- VDI 3805 Part 32:2013-11 "Product data sharing in the mechanical, electrical and plumbing industries – Distributors/collectors"
- VDI 3805 Part 33:2018-09 "Product data sharing in the mechanical, electrical and plumbing industries – Control devices and accessories"
- VDI 3805 Part 35:2008-01 "Product data sharing in the mechanical, electrical and plumbing industries – Butterfly valves, covers and volumetric flow controllers"
- VDI 3805 Part 37:2011-11 "Product data sharing in the mechanical, electrical and plumbing industries – Decentralised façade ventilation units"
- VDI 3805 Part 38 – Project "Product data sharing in the mechanical, electrical and plumbing industries – Floor and roof drainage", planned publication date June 2021
- VDI 3805 Part 40 – Project "Product data sharing in the mechanical, electrical and plumbing industries – Separators", planned publication date October 2021
- VDI 3805 Part 42 – Project "Product data sharing in the mechanical, electrical and plumbing industries – Separating and degassing equipment" planned publication date February 2021
- VDI 3805 Part 43:2019-04 "Product data sharing in the mechanical, electrical and plumbing industries – Pressure retaining equipment"
- VDI 3805 Part 45:2018-11 – Draft "Product data sharing in the mechanical, electrical and plumbing industries – Sanitary objects"
- VDI 3805 Part 99:2014-04 "Product data sharing in the mechanical, electrical and plumbing industries – General components"
- VDI 3805 Part 100:2018-06 "Product data sharing in the mechanical, electrical and plumbing industries – Systems"

### 3.4.3 DIN SPEC 91350

The specification DIN SPEC 91350:2016 "Linked BIM content exchange comprising building information model and specified bill of quantities" defines a linked BIM content sharing of standardised building models e.g. in accordance with ISO 16739 (IFC) and specification of costs and services, e.g. in accordance with PAS 1067 GAEB DA XML.

Within this definition, building models and specifications of services are linked by a specific form of the multi-model method. They are connected by a link model based on identifiers for room and component-orientated elements and sub-services. The data is shared via an archive file designated as a BIM-LV-container, containing the building models, specifications of services, link models and an XML-based description. Software applications are then able to share as standard with each other internally produced links, e.g. between specific components of the building model and specific sub-services of the specification of services.

### 3.4.4 DIN SPEC 91391

The specification DIN SPEC 91391 "Common data environments (CDE) for BIM projects – Functions and open data sharing between different manufacturers' platforms" defines a common data environment (CDE) for collaboration on a BIM building model.

Part 1 "Modules and functions of a common data environment" defines the components and tasks of a CDE, specifies the minimum scope and additional functions and provides an overview of the case studies.

Part 2 "Open data sharing with common data environments" describes an interface concept for data sharing in open BIM projects. It is intended to facilitate seamless and secure data sharing between different platforms.

The specification is currently available as version DIN SPEC 91391-1:2019 and DIN SPEC 91391-2:2019.

### 3.4.5 NBS BIM Object Standard

NBS BIM Object Standard is a British standard published by the Royal Institute of British Architect (RIBA). NBS stands for National Building Specification. The standard defines the description and creation of generic and manufacturer-specific BIM objects. It is being developed in conjunction with the NBS National BIM Library. The NBS National BIM Library is currently the fastest growing BIM library in the United Kingdom.

The current version NBS BIM Object Standard v2.1 defines requirements governing information, geometry, behaviour and visualisation of BIM objects. It sets out criteria for the quality and consistency of components to provide for improved cooperation and fast, reliable and sound decision-making throughout the entire construction industry.

### 3.4.6 COBie

COBie (Construction Operations Building Information Exchange) is a globally used data standard for building information that originates in the USA. It defines non-geometric attributes for use in building management with the aim of achieving a standardised description of rooms and mechanical, electrical and plumbing objects. COBie offers a standardised structure for the creation and documentation of important project data in master data tables to accompany the process. In the course of the project, the tables can be expanded by sanitary engineers, contractors and also with manufacturer's data. Typical information includes the type of device, its manufacturer, the serial number and maintenance interval. COBie standardises information, such as the company headquarters, warranties, spare parts lists and maintenance intervals, to ensure a generally legible basis for data transfer in building management systems.

The first version was published by the United States Army Corps of Engineers as a pilot standard in June 2007. COBie was approved as an NBIMS US Standard by the US National Institute of Building Sciences in December 2011. COBie can be presented in tabular calculations and in the IFC file format. At the start of 2013, buildingSMART drafted the simplified COBie XML format COBie-Lite, which was published in April 2013. In September 2014, COBie was incorporated as Practice into the British standard BS 1192-4:2014 „Collaborative production of information Part 4: Fulfilling employer's information exchange requirements using COBie – Code of practice".

## 3.5 ASSOCIATIONS, BODIES AND PROJECTS

### 3.5.1 buildingSMART

buildingSMART is an expert organisation of companies, educational institutions and private individuals from all sectors of construction, who support the various standardisation processes with their expert knowledge. The organisation has set itself the aim of organising the handling of construction projects in a more integrated and effective manner using methods for integrated information management, thereby making them more reliable in terms of quality, timing and cost. It was against this background that they developed the Industry Foundation Classes (IFC) sharing format for the sharing of BIM content in construction and so laid down the foundation for open BIM.

buildingSMART is a non-governmental non-profit organisation. It comprises the umbrella organisation buildingSMART International and its regional associations. The umbrella organisation coordinates work between the regional associations worldwide. It was founded in 1996 as International Alliance for Interoperability (IAI) and was renamed buildingSMART in 2008. The regional association in Germany is the registered association buildingSMART e.V.

Once a year buildingSMART e.V. organises the buildingSMART Forum in Berlin to publicly present the results of its work. It also organises several BIM User Days every year to share practical experiences with the use of digital building models and establish a network between users.

buildingSMART's work focuses on standardisation in the following areas:

- IFC (International Foundation Classes): basic buildingSMART data model standard (ISO 16739-1:2018)
- IDM (Information Delivery Manual): basic buildingSMART definition of the process (ISO 29481-1:2016)
- MVD (Model View Definitions): sub-categories within IFC files for the definition of data sharing standards
- BCF (BIM Collaboration Format): model-based, software-independent communication protocol.
- bsDD (buildingSMART Data Dictionary): dictionary based on IFD (International Framework for Dictionaries, ISO 12006-3) for the standardisation of buildingSMART terms and designations

### 3.5.2 Normalisation and standardisation bodies

The international and regional normalisation and standardisation organisations ISO, CEN, DIN and VDI have set up bodies for the joint development and mirroring of standards and guidelines for BIM.

In detail they are:

- ISO: ISO / TC 59 / SC 13
- CEN: CEN TC-442
- DIN: Standards committee NA 005-01-39 Building Information Modelling
- VDI: VDI Coordination group on Building Information Modelling

### 3.5.3 Planen-bauen 4.0

After a long lead-in time, the founding contract for "planen-bauen 4.0 – Gesellschaft zur Digitalisierung des Planens, Bauens und Betriebens mbH" ([www.planen-bauen40.de](http://www.planen-bauen40.de)) was signed in 2015 by 14 associations and institutions in Berlin. The foundation of the company goes back to a recommendation by the reform committee "Construction of large-scale projects" under the leadership of the former Federal Minister for Transport Dobrindt. It has the task of shaping, coordinating and supporting the digitalisation of the entire planning, construction and operation value-added chain in Germany. It is intended to help to identify risks and develop solutions for them. The value-added chain encompasses the entire life cycle of buildings, including raw material production, construction, operation and maintenance, demolition and recycling.

The company has a supervisory board and is supported in its work by technical advisory boards. Access to the technical advisory boards is open to all experts without regard to them having a financial stake in the company. The technical advisory boards are set up by the company management with the approval of the supervisory board.

Planen-bauen 4.0 has developed a road map for the introduction of BIM in Germany on behalf of the Federal Ministry of Transport and Digital Infrastructure with the involvement of the shareholders and independent experts. Federal Minister Dobrindt presented this road map to the public on 15 December 2015 at the first German BIM Summit. An initial evaluation of the implementation measures was carried out in January 2017 within the framework of the 2nd BIM Summit.

### 3.5.4 Federal Ministry of Transport and Digital Infrastructure Road Map

The Federal Ministry for Transport and Digital Infrastructure presented a road map for the introduction of BIM to help promote the breakthrough of BIM in Germany on 15.12.2015. It is essential first and foremost for infrastructure construction and infrastructure-related building construction, but can also be used as a model in other areas.

The road map has three stages:

- The first stage (up to 2017) is designed as the preparation stage, in which, for instance, standardisation measures are carried out and guidelines, checklists and templates are developed.
- In the second stage (2017-2020), the initial four pilot projects are to be significantly extended to collect experiences throughout all planning and construction phases. Additional pilot projects in rail, road and waterway modes of transport are in the planning stage.
- In the third stage (from 2020), BIM is to be regularly applied with new projects being planned within the sphere of responsibility of the Federal Ministry of Transport and Digital Infrastructure.

The road map describes, among other things, the required performance level and lists the measures to be taken to prepare for widespread introduction.

The four pilot projects provided for in the second stage are as follows:

- Deutsche Bahn: Rastatt Tunnel, part of the Karlsruhe-Basel track project
- Deutsche Bahn: Filstal Bridge in the Wendlingen-Ulm construction project
- DEGES: Renewal of the bridge over Lake Petersdorf (BAB 19 in Mecklenburg-Vorpommern)
- DEGES: Auenbachtal Bridge, part of the B107 construction project to the south of Chemnitz

### 3.5.5 CAFM-Connect

CAFM-Connect is an initiative launched by associations from the real estate sector, which are committed to the digitalisation of the real estate sector. A standardised and open data standard has been created for this on the basis of IFC to simplify collaboration in the industry.

CAFM-Connect consists of:

- BIM profiles
  - Data sharing standards for BIM applications in the operation of buildings
  - Contractual basis for building owner information requirements (AIA)
  - Published by technical experts with excellent knowledge of the respective case
- CAFM-Connect Editor
  - Free software program for creating buildings and their components and documents based on BIM profiles
  - Suitable for use in compatible CAFM systems
  - It can also be used without installation as a viewer or editor at every workplace

## CHAPTER FOUR

# SOLUTIONS



<b>Family:</b>	Geberit Duofix	Load...
<b>Type:</b>	458.132.00.1	Duplicate...
		Rename...

**Type Parameters**

Parameter	Value
<b>Code Name</b>	
<b>IFC Parameters</b>	
IfcDescription	Geberit Duofix element for wall-hung WC, 112 cm, with Delta concealed cistern 12 cm
IfcExportAs	IfcSanitaryTerminalType
IfcExportType	CISTERN
<b>General</b>	
brandName	Geberit
Product brand	Duofix
type	Delta 12 cm
Article number	458.132.00.1
Product name	Geberit Duofix element for wall-hung WC, 112 cm, with Delta concealed cistern 12 cm
EAN	4025416451211
Characteristics	"Self-supporting frame, powder-coated / Frame top open"
Application purposes	"For drywall construction / For installation in part- or room-height prewall installations"
Scope of delivery	"Angle stop valve R 1/2", with adapter ring/Protection box for service opening, made of polystyrene foam"
Maximum operating temperatur	25 °C
Flush volume, factory setting	5.8 and 3 l
Flush volume large, adjustment	4.5 / 6 / 7.5 l

OK Cancel Apply

## 4.1 EXISTING PROCEDURE

For around five years, the Geberit Group has been providing its customers with BIM manufacturer's data to download free of charge from Geberit websites.

The target group is predominantly MEP planners and architects. Up to now, the company has had BIM models produced in various formats by different service providers and then made them available to customers to download on the local websites of the different subsidiaries.

The existing concepts and procedures have significant shortcomings in view of the increasing importance that BIM is currently experiencing and will continue to experience in future: they are expensive, time-consuming, resource-intensive and, ultimately, present largely static BIM objects. There is also a question about whether the result really meets the needs of the target group.

## 4.2 SCALE OF THE GEBERIT PRODUCT RANGE

A global company, like Geberit, faces a complex challenge due to the enormity of its product range, its links to around 50 different local markets and over 30 languages.

After all, if you pursue the existing approach of producing static objects, then all the different models of every single product relevant for planning would have to be produced as BIM objects, as well as the local derivatives in the respective language. In addition, the product ranges are very different in the markets and local building regulations and standards can also require local variants of models. The following diagram illustrates the complexity generated by the enormity of the product range, languages, product ranges and models. It clearly shows that such a portfolio of BIM objects can no longer be kept under control "manually".

This finding has led to a rethink within the Geberit Group. The objective is a creation and update process for BIM objects that meets the following criteria:

- automated
- a central data source
- proprietary distribution platform
- data sovereignty and control of data

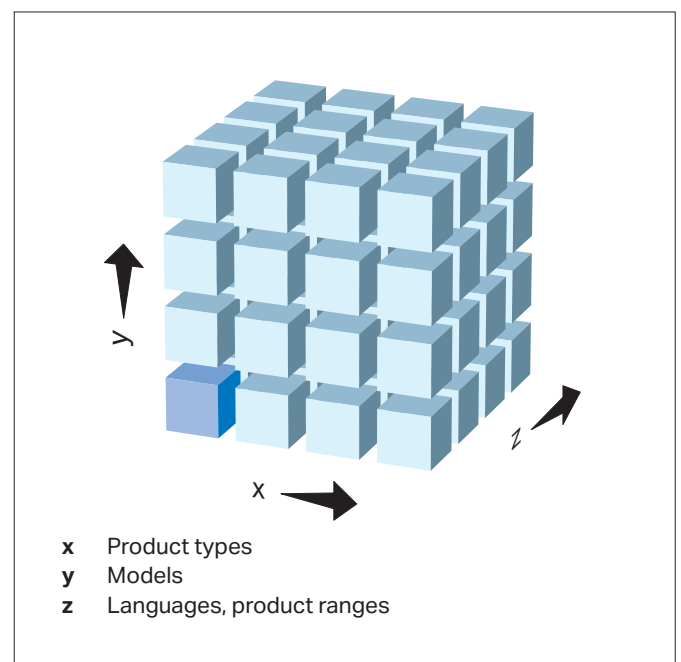

## 4.3 GEBERIT ONLINE SURVEY

### 4.3.1 Background and objectives

The development of viable strategies needs reliable facts. The Geberit Group decided in March 2018 to conduct a global online customer survey to base its future content strategy on a solid foundation. First and foremost, it wanted to find out which software systems and data formats Geberit customers use in the planning of projects and which fundamental requirements they have for digital product data (BIM models).

### 4.3.2 Methodology and execution

The online survey was conducted on the basis of customer addresses from the Geberit customer database in 17 languages and in the following countries and regions: Germany, Austria, Switzerland, the Netherlands, Belgium, France, Italy, Denmark, Finland, Sweden, Norway, the UK, Spain, Poland, Russia, South-east Asia, the Middle East and North Africa.

Architects, MEP consulting engineers, plumbers and general contractors (developers) were primarily the target groups of the online survey. Some facility managers and project managers also took part in the survey.

The survey was created and evaluated internally by Geberit BIM qualified persons. The online survey was programmed, and the field work and evaluation and evaluation of the data was done between April and the end of May 2018 by an external agency.

### 4.3.3 Sampling and response rate

Sampling and the response rate of the total 155,325 contacts resulted in the following figures:

- The net sampling was 3,784 participants. The survey was completed by 3,259 participants.
- The response rate across all countries was 2.4 %, slightly below the average expected with surveys of this type (approx. 3 %).
- The dropout rate was 13.9 %, within the normal range.
- The average time taken to answer the survey was 5:22 minutes.

### 4.3.4 The key results at a glance

#### Use of BIM

Summary:

- Currently 41 % of respondents are working on projects as BIM projects, while an additional 37 % plan to do so in future.
- Around every 5th respondent does not consider BIM to offer any benefits and does not wish to plan or build using digital methods in future.
- BIM does not appear to be particularly widespread particularly in Germany, Austria and Switzerland. In this region, almost every third respondent admitted to not using BIM and not wishing to do so in future either.

Non-use of BIM by target group:

- The use or non-use of BIM varies strongly within the different target groups: While 35 % of all plumbers surveyed do not consider BIM to offer any benefits, this figure falls to merely 10 % amongst architects and MEP planners (across all countries).
- The aversion to the use of BIM is considerably higher in Germany, Austria and Switzerland. Approx. 50 % of plumbers, 20 % of architects and approx. 15 % of MEP planners do not consider BIM to offer any benefits or there to be any need for it.

Reasons for not using BIM:

- Apart from a lack of experience, the main reason for this reluctance could also be due to a lack of knowledge about the benefits and advantages of digital construction. A significant number of those surveyed knows little or nothing about the basics of BIM.
- What is more, there does not yet appear to be a demand by the different customer groups ("no demand", "no need", "not needed"). This statement does not apply equally to all countries as BIM is more widespread in certain countries than in other countries.

Requirements of BIM manufacturer's data:

- BIM manufacturer's data is required across all target groups. Owners, general contractors and/or developers in particular as well as architects are demanding BIM manufacturer's data.
- The geographic region plays a key role among MEP consulting engineers: in Finland, the United Kingdom and in Russia and in the so-called "emerging markets", MEP consulting engineers are increasingly calling for BIM manufacturer's data. While facility managers are also calling for BIM manufacturer's data in Belgium, Denmark and Sweden, it is plumbers in the Benelux and, above all, in Norway who are calling for it.

## Level of detail and classification standard

Manufacturer-neutral or manufacturer-specific BIM content:

- The question about manufacturer-specific or manufacturer-neutral or generic BIM content was answered differently. Whereas some participants are of the opinion that there needs to be manufacturer-specific BIM content available at the draft planning stage, others are of the opinion that this should be available at latest from execution planning and installation planning stages onwards.
- Overall, both manufacturer-specific and also generic or manufacturer-neutral BIM content is deemed necessary.

Classification standard:

- IFC is regarded as the classification standard and is requested most frequently across all countries and regions. Having said that, there are clear differences between the countries. For instance, IFC only plays a subordinate role in the United Kingdom.
- Really only Germany, Austria and Switzerland, as well as Poland, largely call for classification according to VDI 3805 / ISO 16757.
- The use of BIM manufacturer's data according to VDI 3805 / ISO 16757 currently only has a certain level of importance in Germany, to a lesser extent also in Austria and Norway.

Procurement channel for manufacturer's specific BIM content:

- The majority of participants primarily procure manufacturer-specific BIM content from the manufacturer's website.
- The online platform most widely used or the plug-in most widely used is BIMobject. Although there are once again country-specific differences here, BIMobject is in the Top 3 of platforms or plug-ins used in all countries and regions.

## Data formats and software

Data formats:

- IFC as well as native formats, such as Autodesk® Revit® (.rvt) are relevant as data formats for data sharing.
- IFC is clearly favoured in Germany, Austria, Switzerland, and in Sweden and in Finland.
- Customers in Denmark, the United Kingdom, Italy, Spain, Poland, Russia and in the GISA markets prefer native formats.

Software:

- There is no clear picture when it comes to the software used for the various applications (integrated model, architecture, cross-trade collaboration, pipework calculation and tender/quantity determination). There is no "standard software" used in all countries and by all target groups. Numerous entries under "Other" underline this finding.

## Summary

The following conclusion can be drawn from the results of the survey:

- There is still great uncertainty and little knowledge or expertise about the issue of "BIM projects" in all countries. Everyone is using whatever they think is right – standardisation is still a distant prospect.
- There is currently far less a "European" standard solution for the respective applications. To a certain extent, there are clear preferences in each country, which are then very different in the directly adjacent country.
- By contrast, this general uncertainty also offers the possibility of setting or helping to shape standards. At least in some countries, the issue of BIM is being driven forward, above all, by software manufacturers and in the specialist media. The issue has by far not 'totally' arrived among the target groups.



### 4.3.5 Results in detail

#### Participants

Customers from 15 countries and 2 regions were contacted in the online survey. There were different numbers of participants between the countries owing to the different number of customers contacted in each country and the subsequent response rates. In Germany, for instance, 694 customers took part, while only 84 customers responded from Sweden.

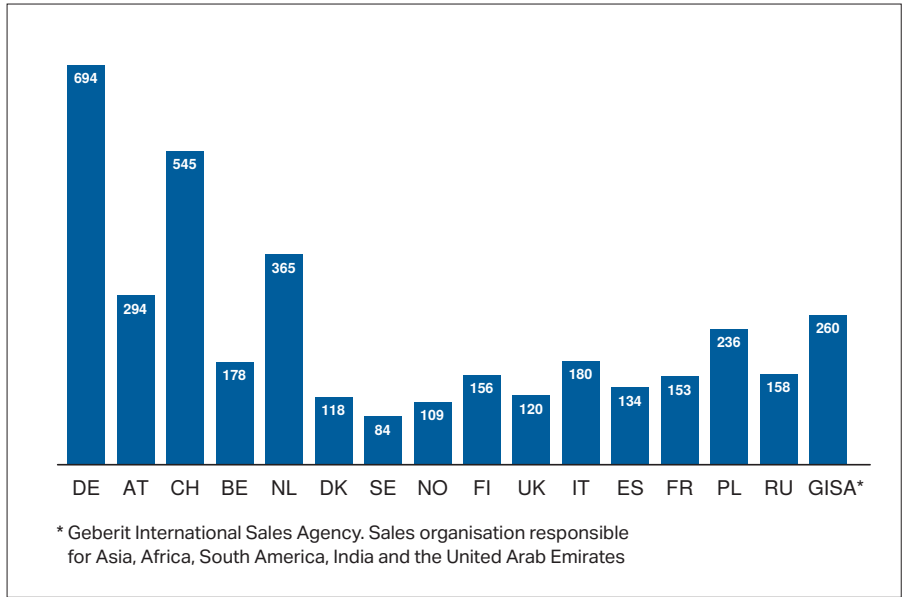

Sampling varied significantly from country to country in relation to the target groups. Plumbers, MEP planners and consulting engineers were the groups most widely represented across all countries.

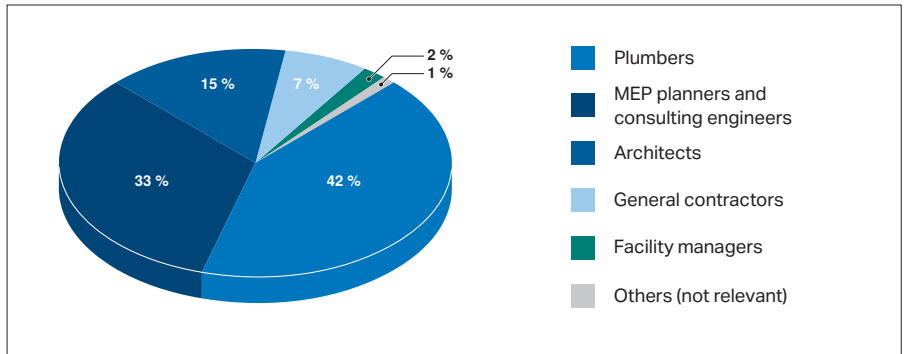

## Use of BIM

### Which of the following descriptions fits your company?

The composition of the sampling varies greatly from country to country. In the overall evaluation across all countries, plumbers and MEP planners or consulting engineers are the groups most widely represented.

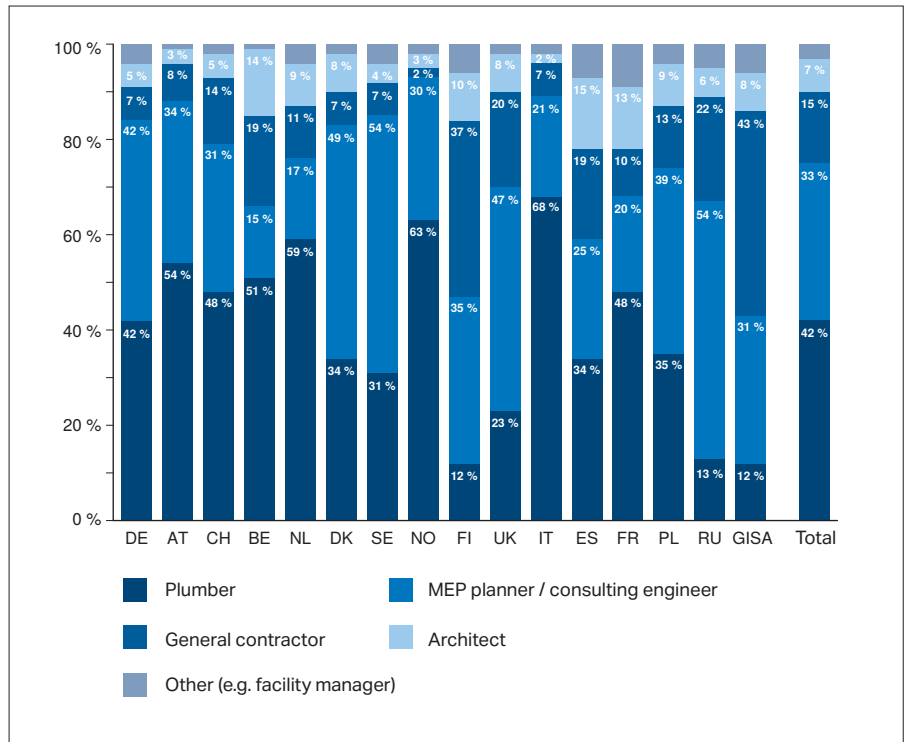

### Are you already undertaking projects as BIM projects?

Evaluation by country:

41 % of all respondents are currently undertaking BIM projects. However, there are significant differences between the individual countries. BIM is used below average in Germany, Austria, Switzerland and in Italy and Spain. Whereas BIM has above-average use in Scandinavia, the Netherlands, the United Kingdom and in the GISA\*.

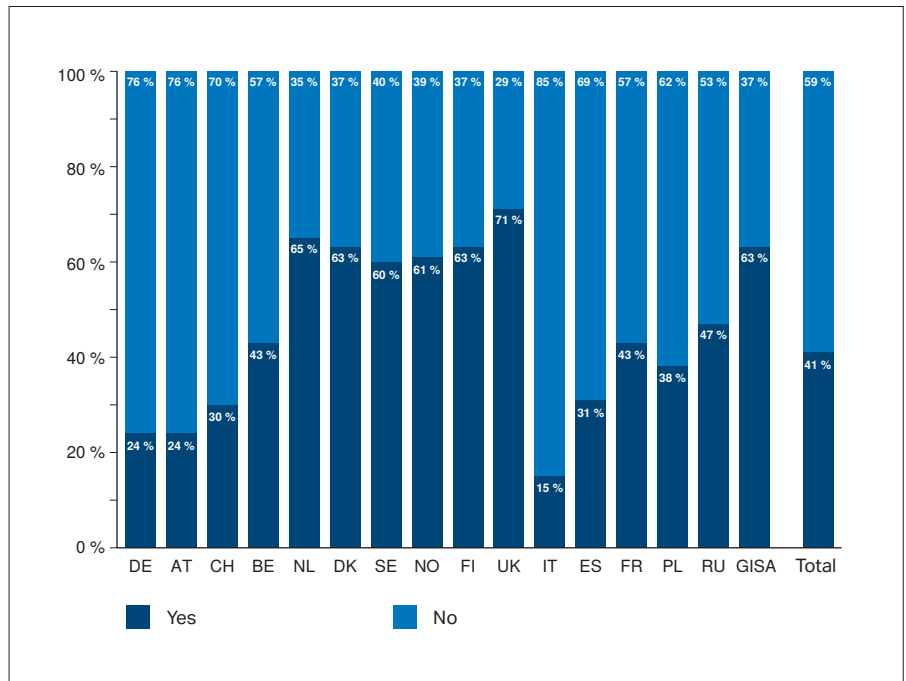

\* Geberit International Sales Agency, sales organisation responsible for Asia, Africa, South America, India and the United Arab Emirates

Evaluation by target group:

There are also significant differences in relation to the current use of BIM amongst target groups. While 59 % of architects and MEP planners are already using BIM, only 20 % of plumbers are using it. However, a significant number of respondents (27–45 %) is currently not using BIM amongst all target groups.

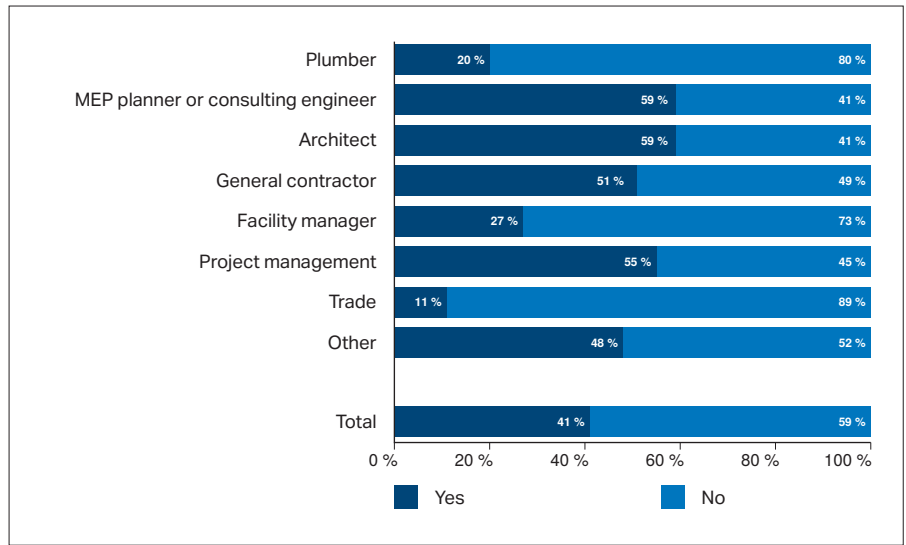

Do you plan to undertake projects using BIM in future?

Evaluation by country:

The majority of all respondents is planning the future use of BIM.

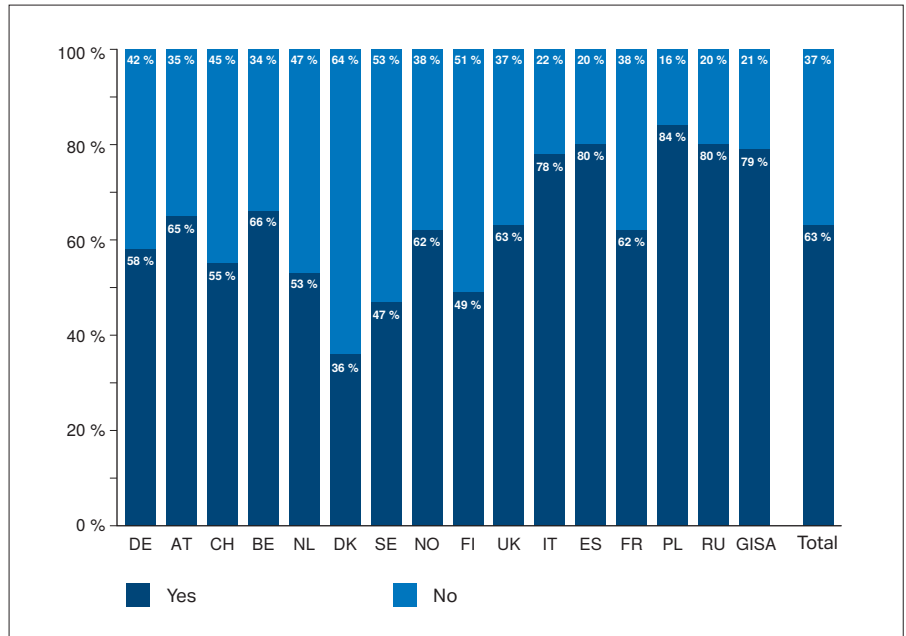

Evaluation by target group:

The majority of all respondents is planning the future use of BIM.

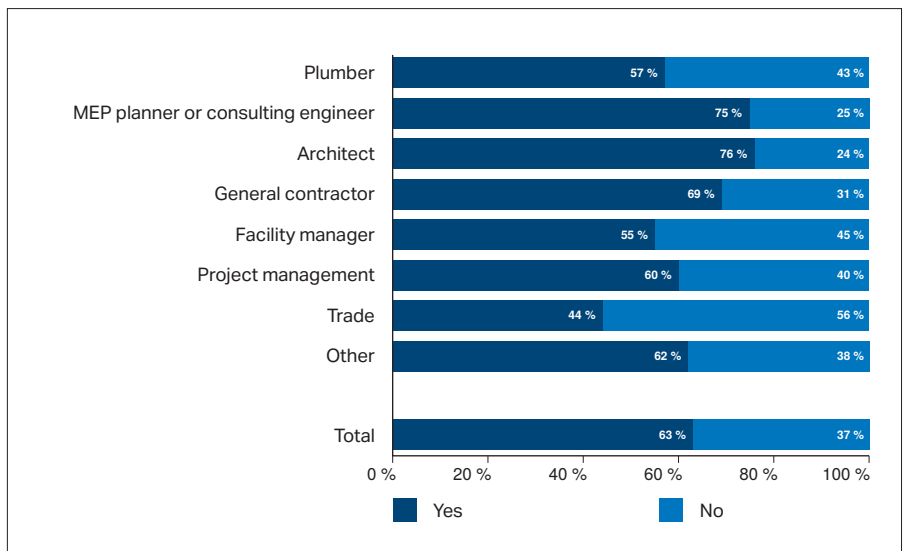

**Why are you not using BIM for your projects?**

Plumbers, at more than a third, are by far the largest group of respondents not currently using and not planning to use BIM in future. The percentage at > 50 % in each country is extremely high in Germany, Switzerland and Sweden (very small target group).

The main reason for not using BIM and not wanting to use it in future is based on a lack of knowledge about BIM and/or a lack of experience with the method (32 %).

A further 27 % of those surveyed see no reason to use BIM, as they generally do not deal with projects in which its use would be needed, or the use of BIM is not required by customers.

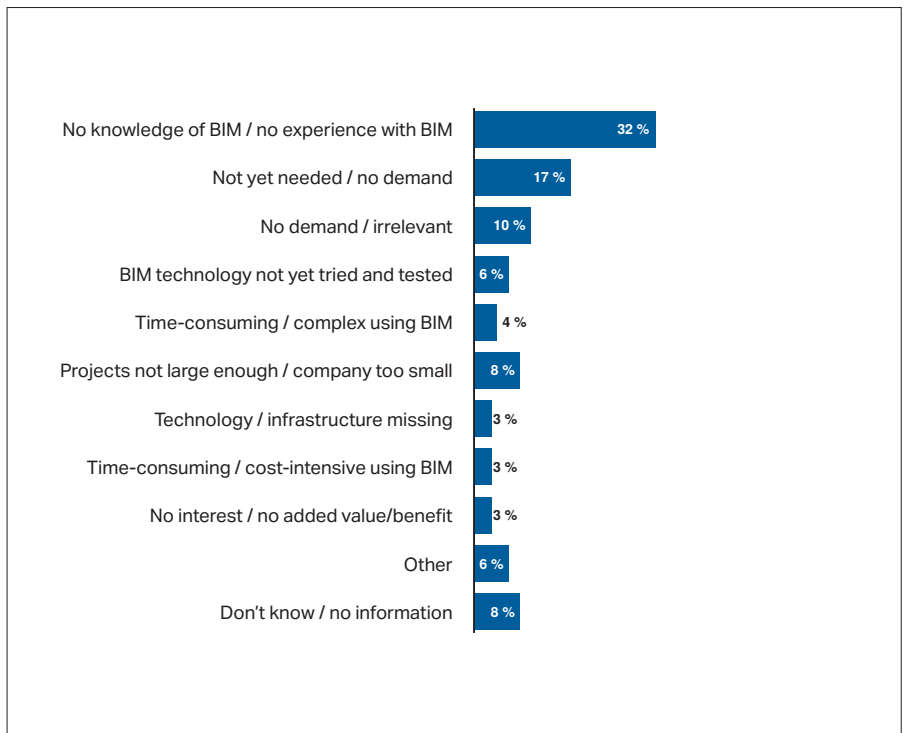

**Who is asking for BIM models from you?**

Evaluation by target group:

Owners, general contractors and architects are calling for BIM models most frequently in all countries.

When considering the individual countries, MEP planners in Finland (31 %), the UK (37 %), Russia (27 %) and the GISA (37 %) also play a key role. Facility Managers in Belgium (23 %), Denmark (24 %) and Sweden (21 %) are also calling for BIM models. Plumbers in Belgium (20 %), the Netherlands (29 %) and Norway (30 %) also play a key role.

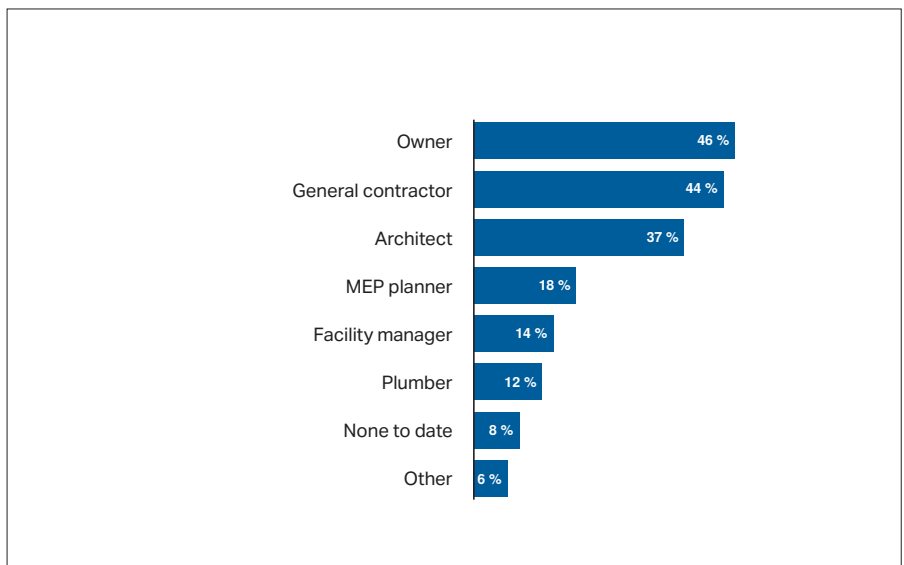

**Top 3 evaluation by country:**

<b>Germany</b>		
1. Owner	40 %	
2. Architect	40 %	
3. General contractor	31 %	

<b>Austria</b>		
1. General contractor	47 %	
2. Owner	44 %	
3. Architect	40 %	

<b>Switzerland</b>		
1. Architect	51 %	
2. General contractor	46 %	
3. Owner	45 %	

<b>Belgium</b>		
1. Architect	46 %	
2. Owner	45 %	
3. General contractor	34 %	

<b>The Netherlands</b>		
1. General contractor	57 %	
2. Owner	51 %	
3. Architect	38 %	

<b>Denmark</b>		
1. General contractor	66 %	
2. Owner	59 %	
3. Architect	39 %	

<b>Sweden</b>		
1. Owner	65 %	
2. General contractor	47 %	
3. General management	21 %	

<b>Norway</b>		
1. General contractor	80 %	
2. Owner	41 %	
3. Architect	41 %	

<b>Finland</b>		
1. Owner	69 %	
2. General contractor	56 %	
3. Architect	32 %	

<b>UK</b>		
1. General contractor	55 %	
2. Owner	54 %	
3. Architect	45 %	

<b>Italy</b>		
1. General contractor	43 %	
2. Owner	26 %	
3. Architect / MEP	14 %	

<b>Spain</b>		
1. Owner	60 %	
2. General contractor	27 %	
3. Architect	21 %	

<b>France</b>		
1. Architect	48 %	
2. General contractor	38 %	
3. Owner	36 %	

<b>Poland</b>		
1. General contractor	43 %	
2. Owner	41 %	
3. Architect / MEP	37 %	

<b>Russia</b>		
1. General contractor	51 %	
2. Owner	38 %	
3. MEP planner	27 %	

<b>GISA</b>		
1. Owner	48 %	
2. MEP planner	37 %	
3. Architect	35 %	

**From which phase of a project should manufacturer-specific BIM content be available in the model?**

Evaluation across all countries:

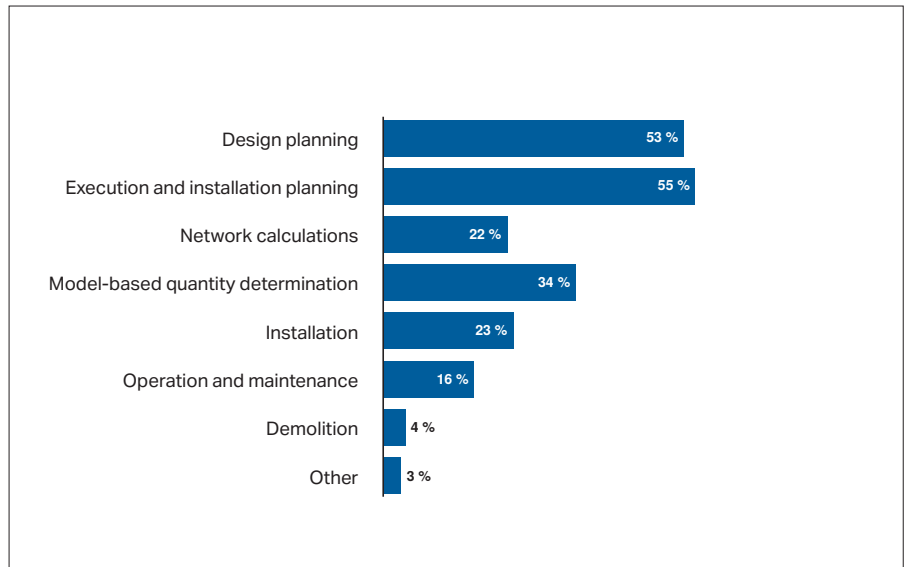

Evaluation by target group:

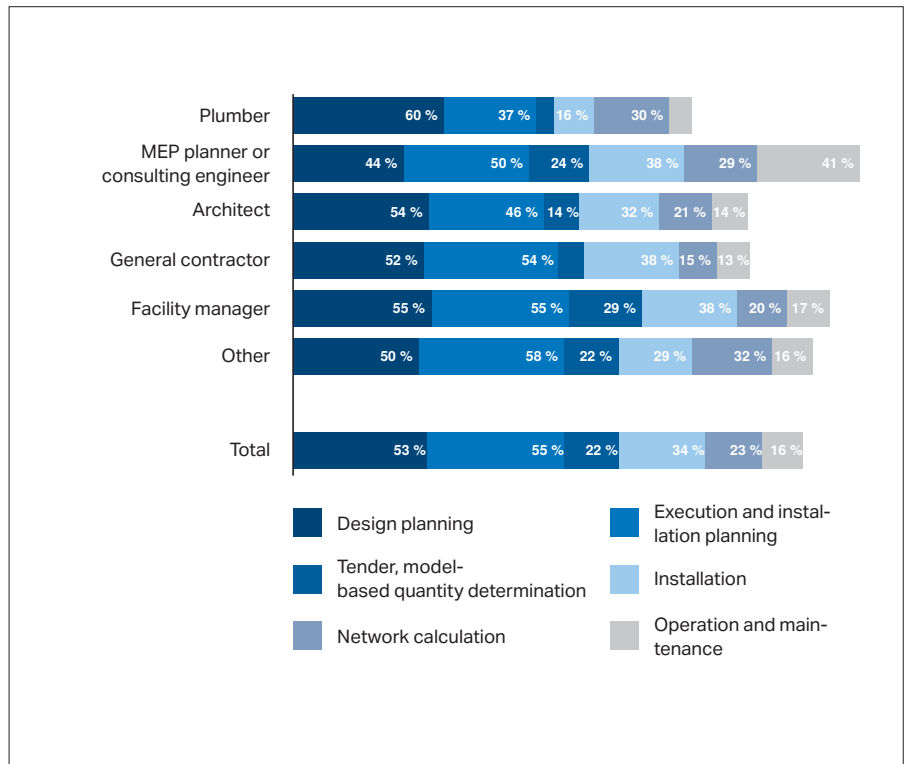

Evaluation by country:

Among the respondents, the demand for manufacturer-specific BIM content to be available in the model is clearly from the design planning stage onwards and, at latest, from the execution and installation planning phase. The differences in the results were minimal between the target groups and countries.

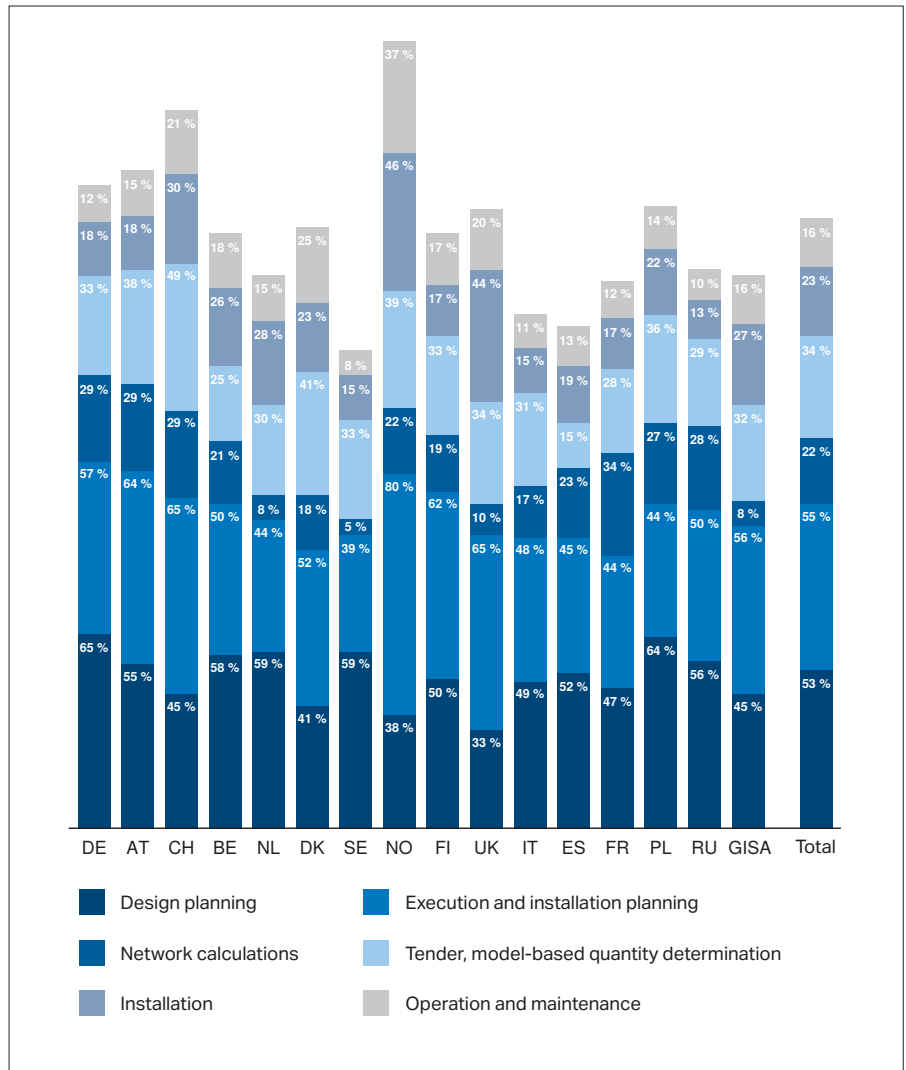

## Use of BIM software

### Which software do you currently use or do you plan to use in the integrated model, particularly for MEP planning?

Evaluation across all countries.

Viewed across all countries, Autodesk® Revit® is by far the most widely used software (38 %). However, the collective “Other software” comes in second place, once again underlining the wide range of software used.

A high number of respondents admitted that software was not relevant to them for the integrated model: Italy (30 %), Finland (21 %) and the UK (19 %).

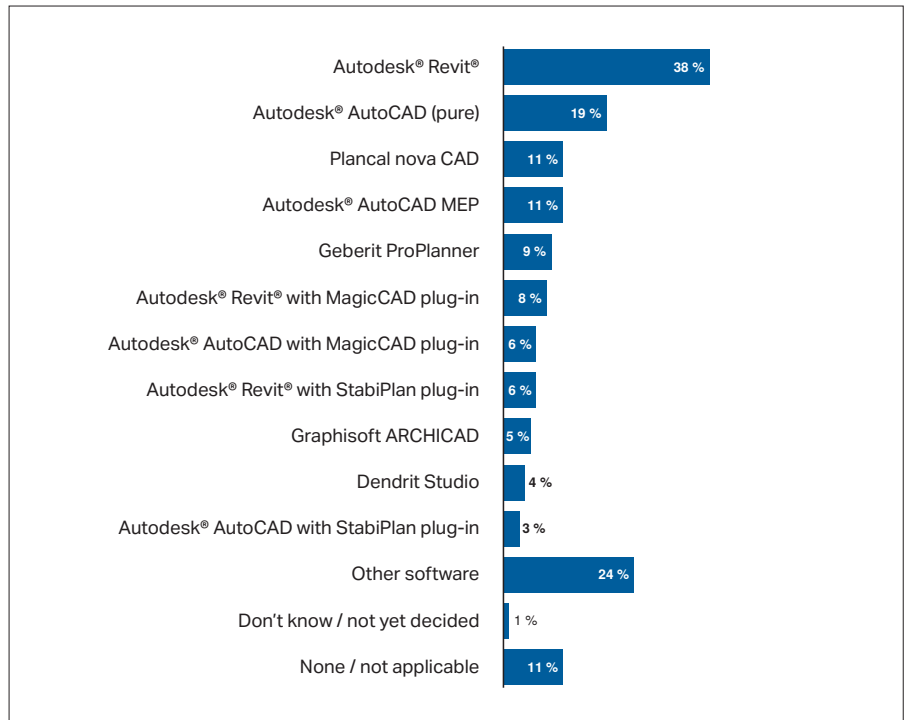

















**Top 3 evaluation by country:**

The responses to the question about the software used, particularly for MEP planning, reveal a picture far removed from a prevalent "standard software". Each country has its own software preferences. Numerous different software brands listed under

"Other" underline the findings about the wide range of software. For instance, in Germany alone there were an additional 20 open software brands named.

<p><b>Germany</b> </p> <p>1. Owner 24 % 2. Architect 20 % 3. General contractor 20 %</p>	<p><b>Austria</b> </p> <p>1. General contractor 44 % 2. Owner 18 % 3. Architect 16 %</p>	<p><b>Switzerland</b> </p> <p>1. Architect 31 % 2. General contractor 22 % 3. Owner 20 %</p>
<p><b>Belgium</b> </p> <p>1. Architect 43 % 2. Owner 19 % 3. General contractor 14 %</p>	<p><b>The Netherlands</b> </p> <p>1. General contractor 52 % 2. Owner 37 % 3. Architect 21 %</p>	<p><b>Denmark</b> </p> <p>1. General contractor 60 % 2. Owner 52 % 3. Architect 22 %</p>
<p><b>Sweden</b> </p> <p>1. Owner 68 % 2. General contractor 28 % 3. General management 27 %</p>	<p><b>Norway</b> </p> <p>1. General contractor 46 % 2. Owner 38 % 3. Architect 20 %</p>	<p><b>Finland</b> </p> <p>1. Owner 36 % 2. General contractor 22 % 3. Architect 19 %</p>
<p><b>UK</b> </p> <p>1. General contractor 66 % 2. Owner 16 % 3. Architect 15 %</p>	<p><b>Italy</b> </p> <p>1. General contractor 30 % 2. Owner 24 % 3. Architect / MEP 8 %</p>	<p><b>Spain</b> </p> <p>1. Owner 52 % 2. General contractor 25 % 3. Architect 10 %</p>
<p><b>France</b> </p> <p>1. Architect 48 % 2. General contractor 28 % 3. Owner 14 %</p>	<p><b>Poland</b> </p> <p>1. General contractor 45 % 2. Owner 26 % 3. Architect / MEP 17 %</p>	<p><b>Russia</b> </p> <p>1. General contractor 62 % 2. Owner 59 % 3. MEP planner 22 %</p>
<p><b>GISA</b></p> <p>1. Owner 66 % 2. MEP planner 34 % 3. Architect 24 %</p>		

**Other brands of BIM software used:**

**France**

- Autodesk® Revit® with StabiPlan plug-in 11 %
- Plancal nova 10 %

**Germany**

- Geberit ProPlanner 18 %
- Autodesk® AutoCAD MEP 12 %
- Autodesk® AutoCAD (pure) 9 %
- Autodesk® AutoCAD with liNear Plug-in 7 %
- 20 other brand names listed 5 %

**The Netherlands**

- Autodesk® AutoCAD (pure) 11 %

**Russia**

- Autodesk® Revit® with MagiCAD plug-in 14 %
- Autodesk® AutoCAD MEP 11 %

**Austria**

- Autodesk® AutoCAD (pure) 13 %
- 20 other brand names listed 7 %

**Switzerland**

- Bausoft Haustechnik CAD 13 %
- Autodesk® AutoCAD (pure) 11 %

**Norway**

- Autodesk® AutoCAD (pure) 12 %
- Autodesk® AutoCAD MEP 11 %

**Denmark**

- Autodesk® AutoCAD (pure) 12 %

**Poland**

- Autodesk® Revit® with MagiCAD plug-in 13 %

**Which software are you currently using in the integrated model or do you plan to use in future in architecture?**

Software solutions are irrelevant for the majority of respondents in architecture. However, when individual target groups are considered, it becomes clear that software does not play an important role for 3 % of architects. Plumbers (74 %), MEP planners and consulting engineers (62 %), facility managers (53 %) and general contractors (30 %) therefore make up 53 % of the respondents for whom the software is unimportant.

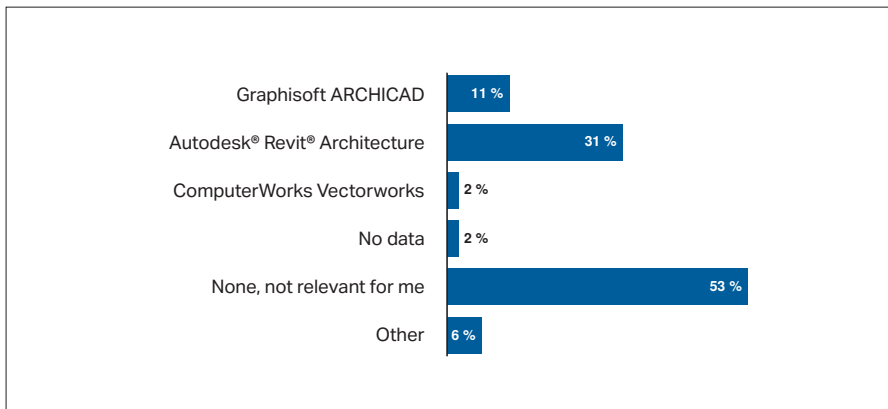

**Evaluation by country:**

Autodesk® Revit® Architecture is used most frequently by the respondents. Graphisoft ARCHICAD is most popular in Finland.

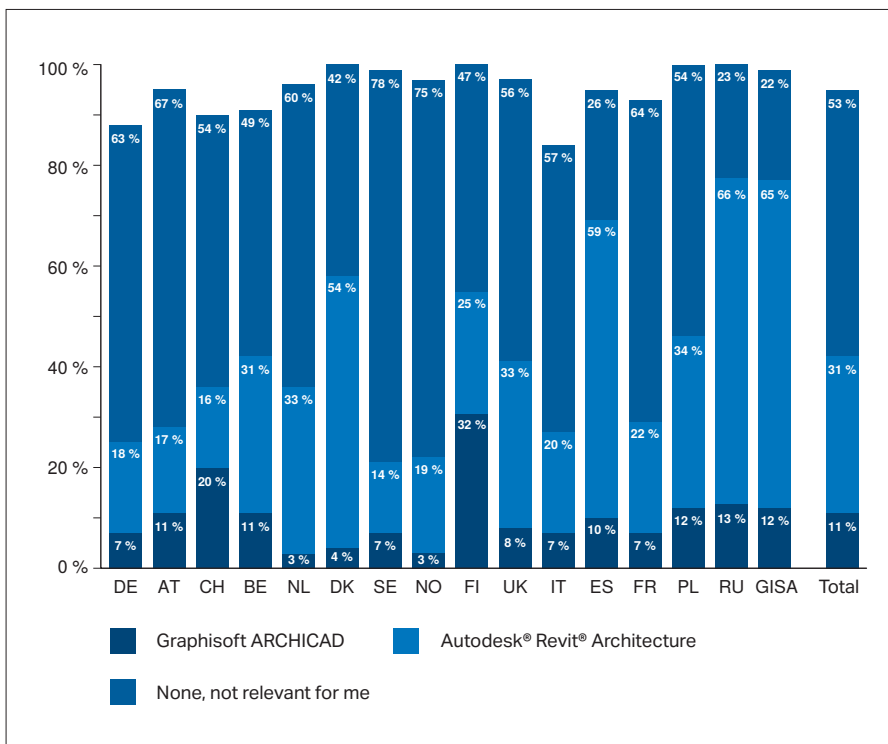

**In cross-trade collaboration, which software are you currently using in the federated model or do you plan to use in future?**

Software solutions in cross-trade collaboration are irrelevant for the majority of the respondents.

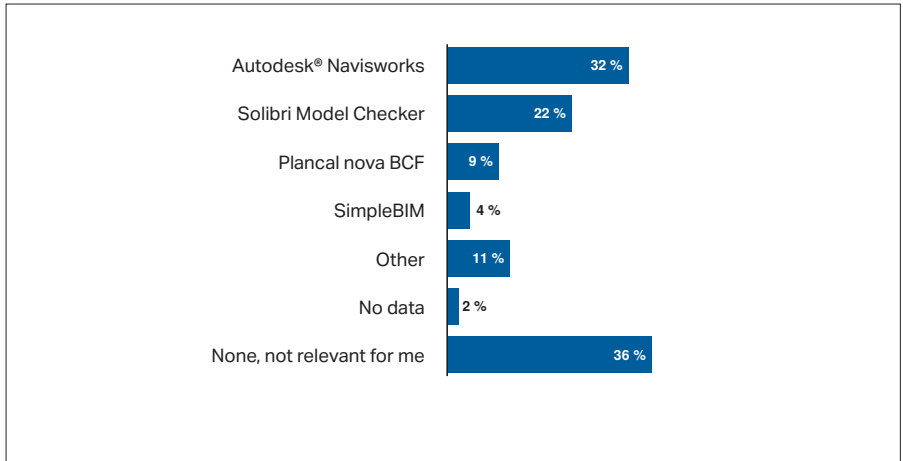

**Evaluation by country:**

When considered across all countries, Autodesk® Naviworks is the most widely used software in this sector. By contrast, Solibri Model Checker stands out as the most popular software when individual countries are considered, especially Scandinavia and the Netherlands.

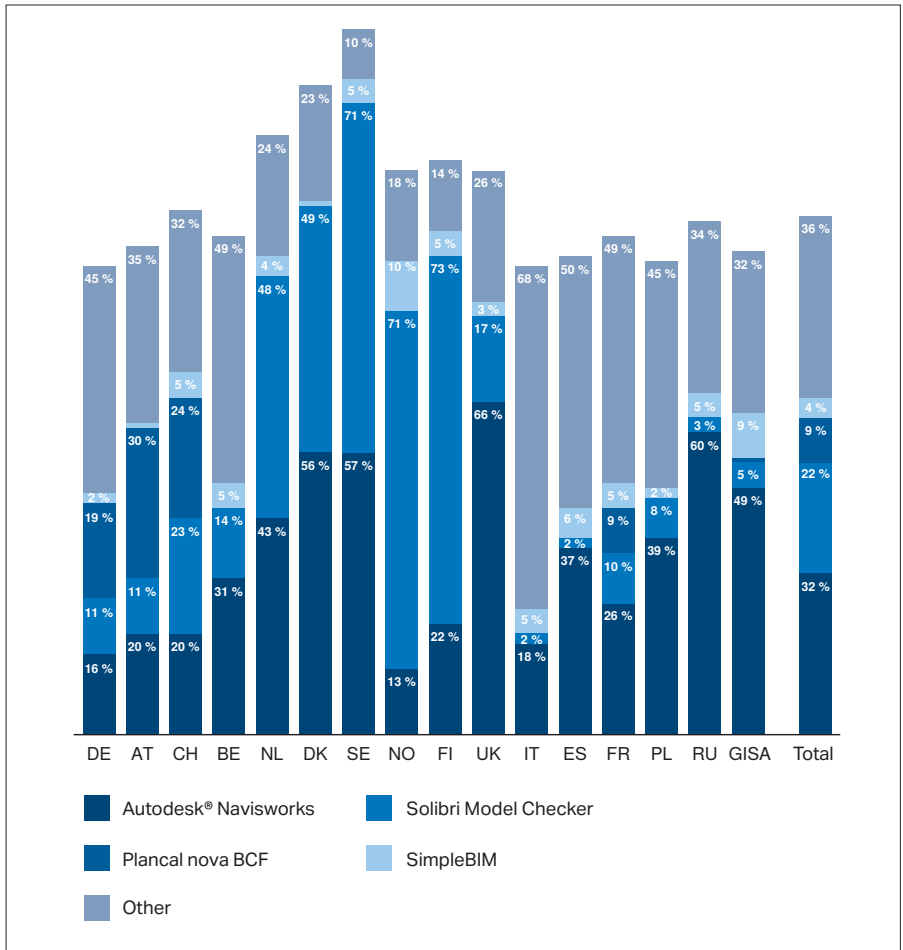

**In pipe network calculations, which software are you currently using in the federated model or do you plan to use in future?**

Software solutions in pipe network calculations are irrelevant for the majority of respondents. A wide number of software versions can be identified amongst the respondents who use software in pipe network calculations.

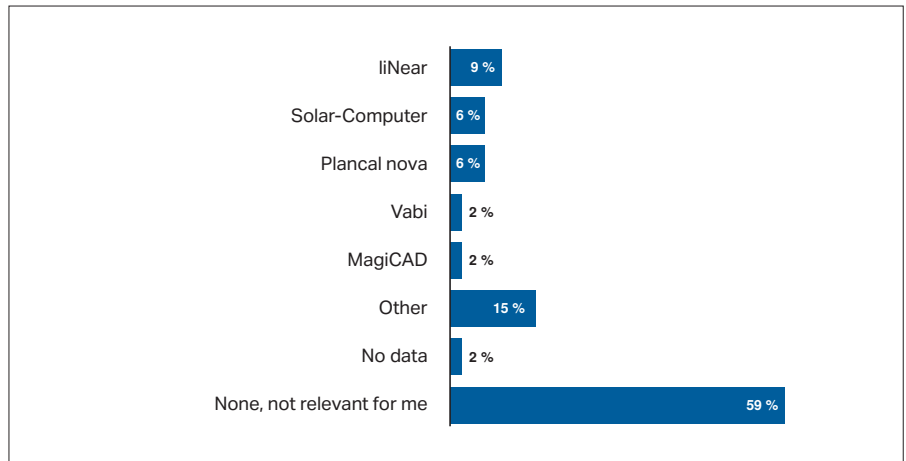

**Evaluation by country:**

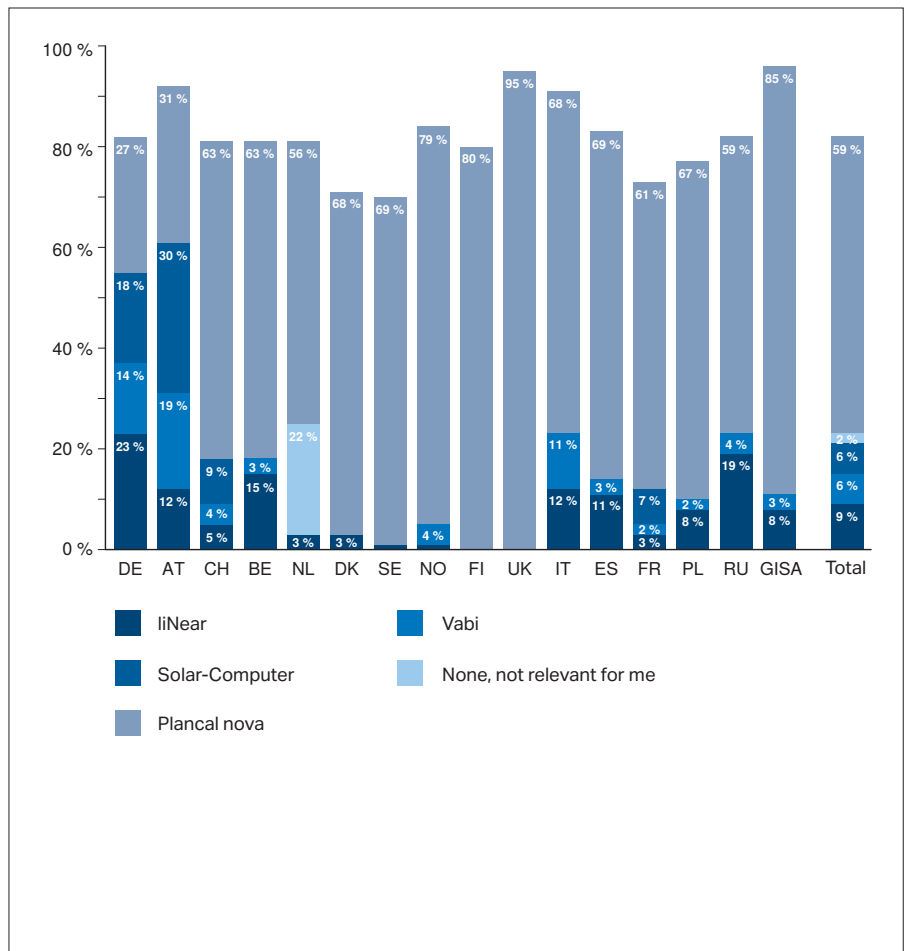

**In tenders and quantity determination, which software are you currently using in the federated model or do you plan to use in future?**

Software solutions in tenders and quantity determination are irrelevant for the majority of respondents. A wide number of software versions can be identified amongst the respondents who use software in tenders and quantity determination.

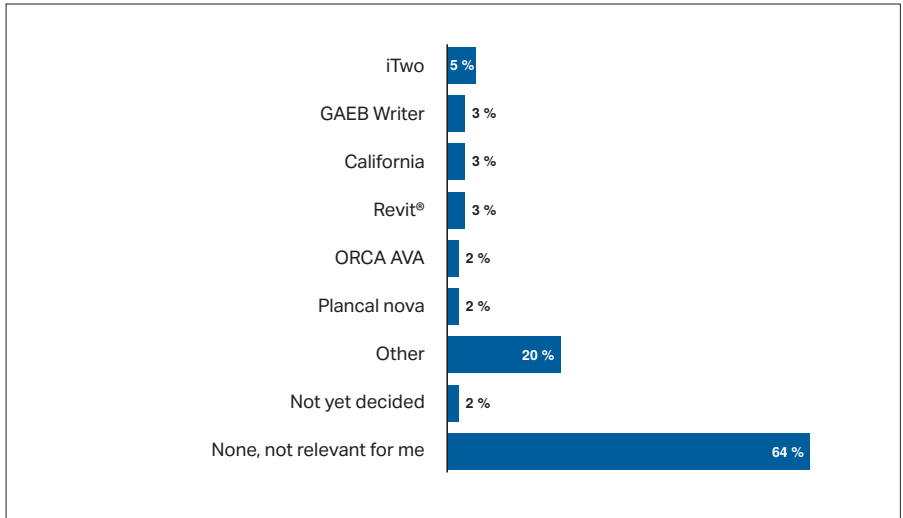

**Evaluation by country:**

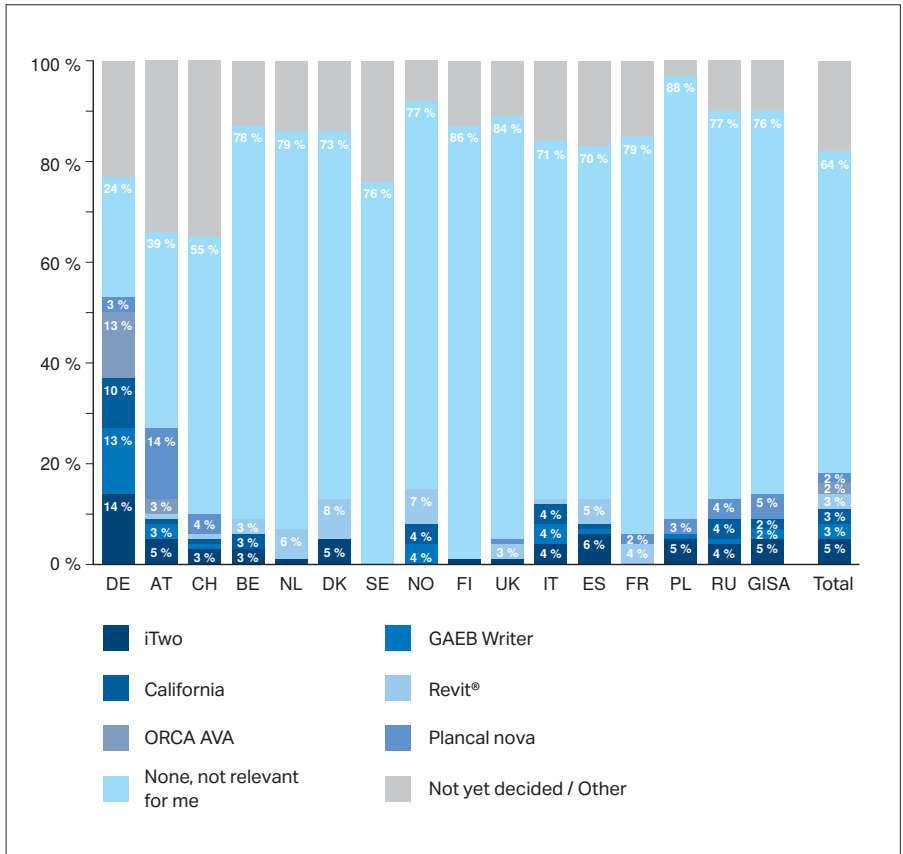

## Need for information

### What kind of content/data do you need for your BIM projects?

Evaluation by country:

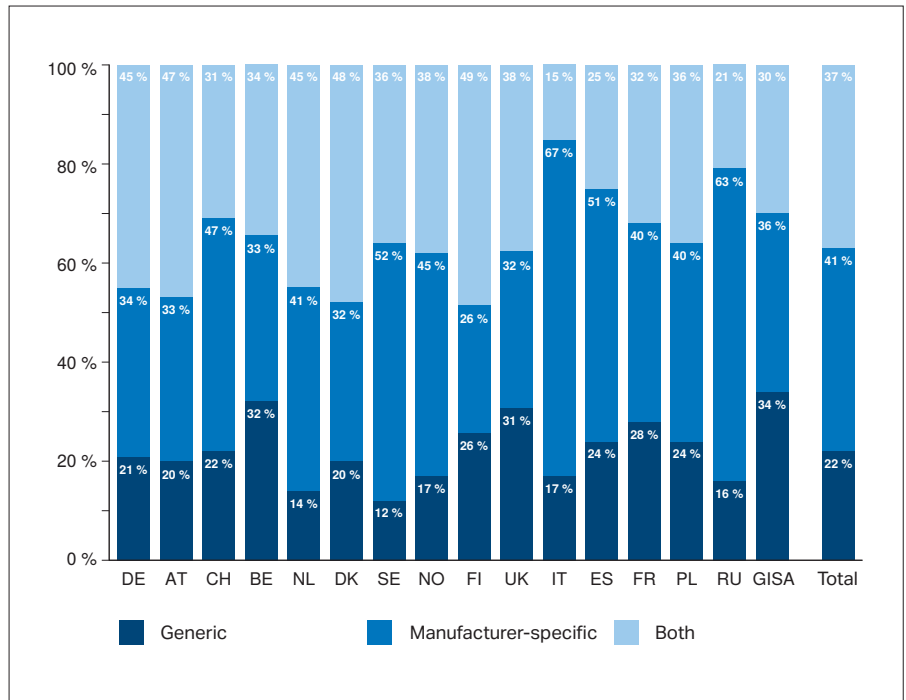

Evaluation by target group:

The majority of statements (41 %) refer to manufacturer-specific data. Over one third of the respondents need both manufacturer-specific and also generic data. Overall, it can be concluded that the majority of respondents prefer manufacturer-specific models and data.

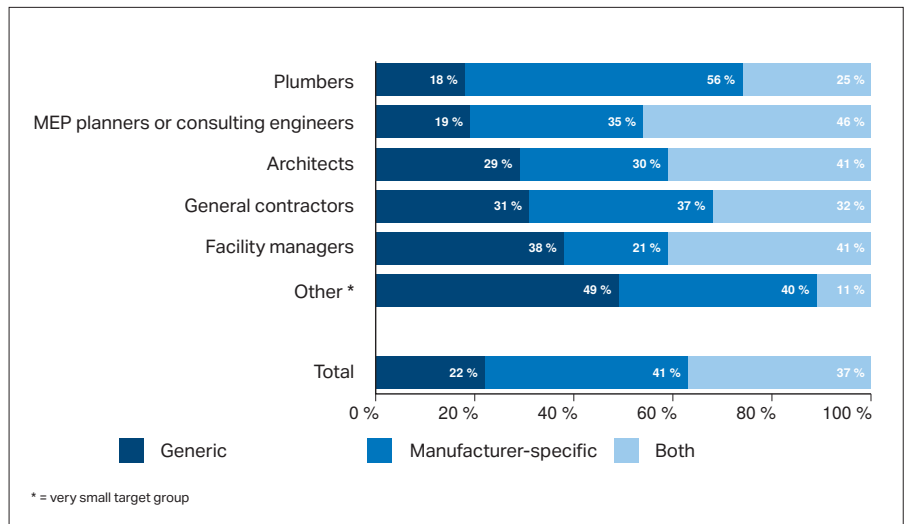

**What geometric level of detail do you prefer for your application?**

Evaluation by country:

There is no clear picture relating to the geometric level of detail. To a greater extent, approximately one third of the respondents voted for one of three levels of detail: rough, medium or fine level of geometric detail.

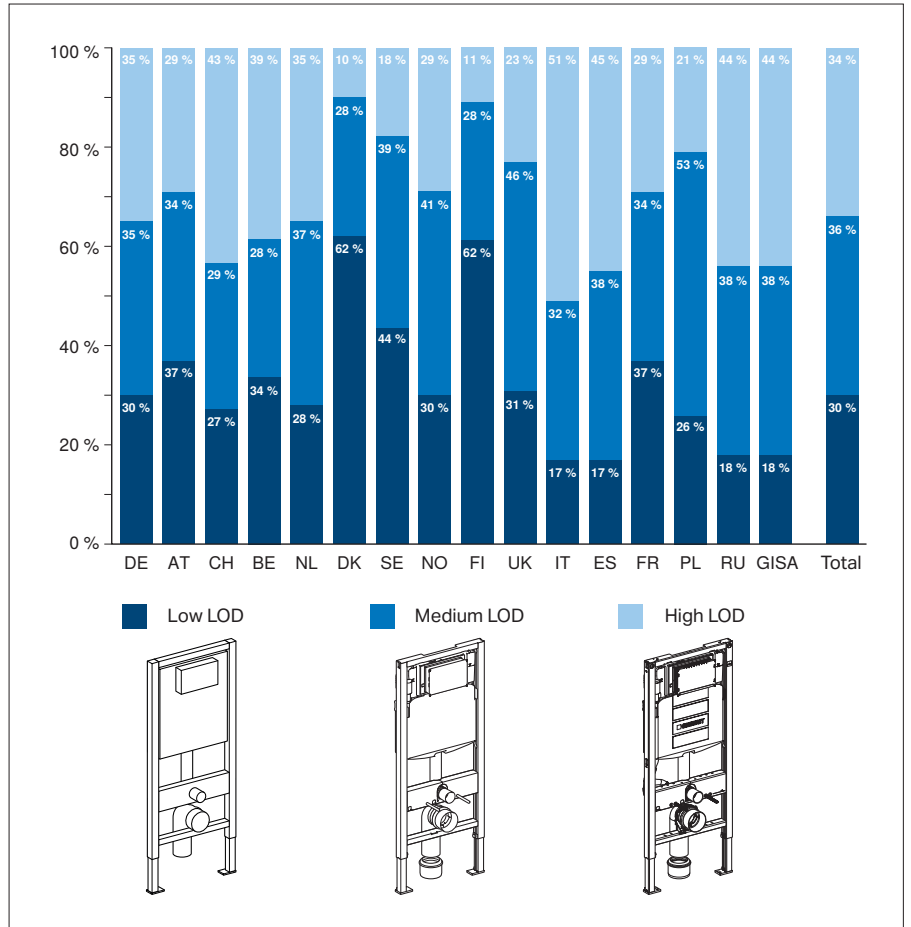

Evaluation by target group:

However, clear preferences can be identified by target group: architects prefer a low level of detail, while facility managers and plumbers would like a high level of detail.

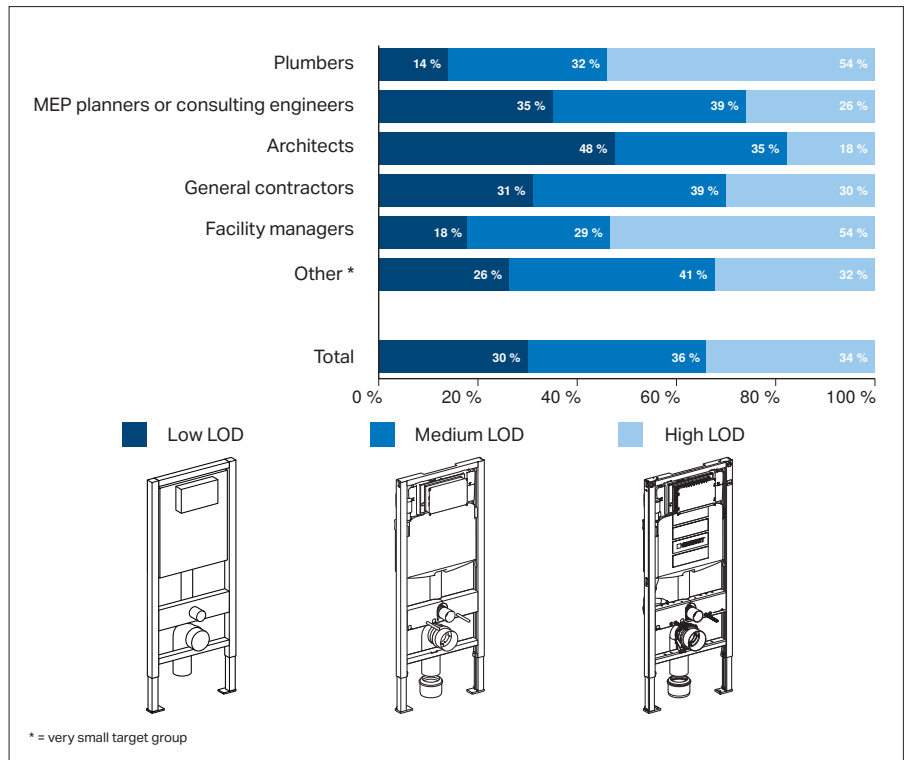

\* = very small target group

**What depth of information (metadata) do you prefer for your application?**

Evaluation by country:

The majority of respondents prefers components with a large depth of information, suitable for calculations.

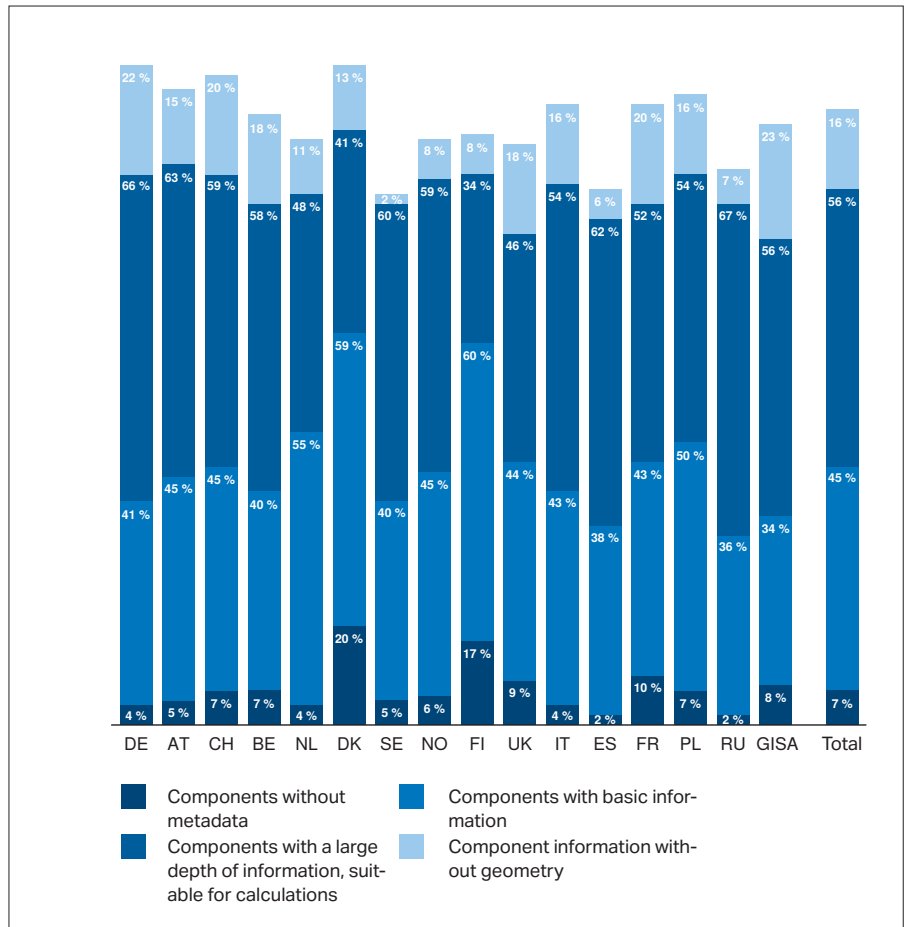

Evaluation by target group

Based on each target group, architects primarily prefer components with basic information and plumbers as well as MEP planners would like components with a large depth of information.

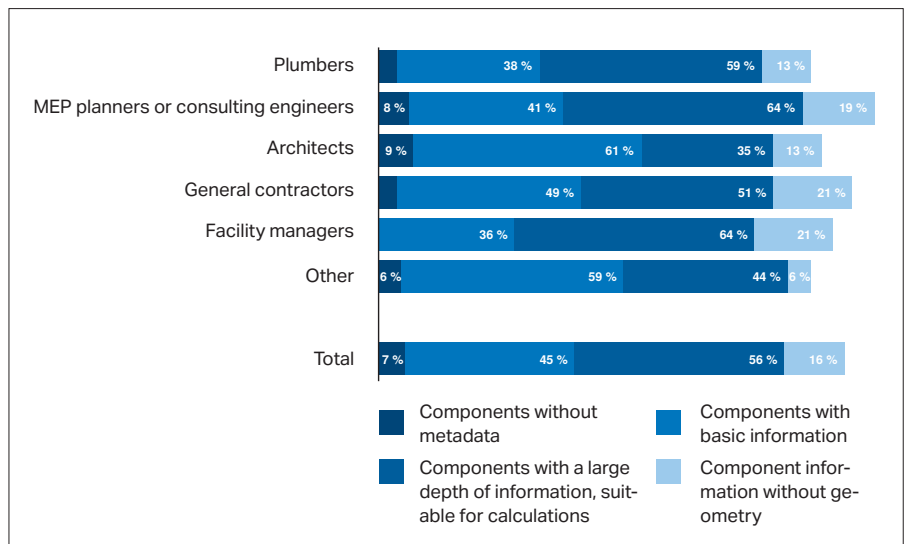



**Are there details in BIM components which have been unnecessary or counter-productive in previous BIM projects you have worked on? Conversely, what would have been important to you?**

The majority of respondents have no suggestions for improvement (36 %) or cannot answer the question as they are not sufficiently conversant with the issue (34 %). The remaining respondents had a large number of comments about superfluous details in BIM components and what was important to them.

Their responses can be summarised as follows:

**Details in BIM components which have been unnecessary or counter-productive in previous BIM projects you have worked on (Top 3):**

1. Detailed 3D geometry / Keep file size minimal to avoid a complex integrated model **21 %**
2. High level of detail (metadata / geometry), cleanliness needed in modelling **7 %**
3. Incomplete Geberit BIM library: not all product groups are available, modelling of the entire pipe system or project cannot be completed **3 %**

**Conversely, what would be important to you (Top 4):**

1. Connection points, dimensional data, calculation parameters, standardised designation of parameters to be able to automatically create a plan **18 %**
2. Product-specific details needed: brand, article number, mass, weight, costs **7 %**
3. Cross-trade and project-specific metadata. The possibility of adapting the LOI + LOD at each phase **6 %**
4. Adaptability (e.g. to meet needs on site), parametrisation (e.g. a product range with several models), LOD as required **5 %**

## Standards

### In your opinion, according to which standards should BIM content be classified?

Viewed across all countries, IFC classification is by far the most popular choice (44 %). Similar to the responses to the question about BIM software, the collective "Other" comes in second place, clearly illustrating that the world of BIM is still far from standardised data classification in terms of classification standards as well.

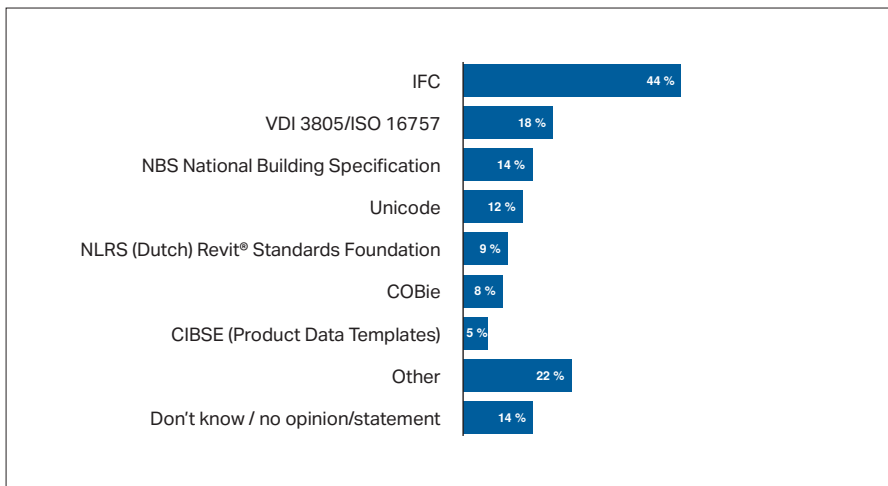

### Classification according to the IFC standard – Detailed evaluation by target group:

When considering the statements made about classification according to the IFC standard by target group, it is clear that MEP planners, architects and general contractors, above all, prefer this type of BIM content classification.

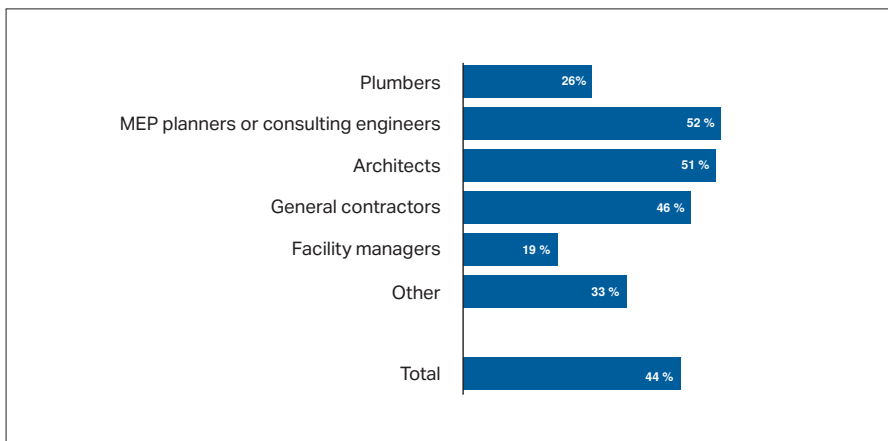

### Classification according to the VDI standard – Detailed evaluation by target group:

Considering the responses made about classification according to the VDI standard by target group reveals a relatively balanced distribution amongst the target groups. Architects are the exception to this, who tended to vote below average (7 %) for the VDI standard for the classification of BIM content.

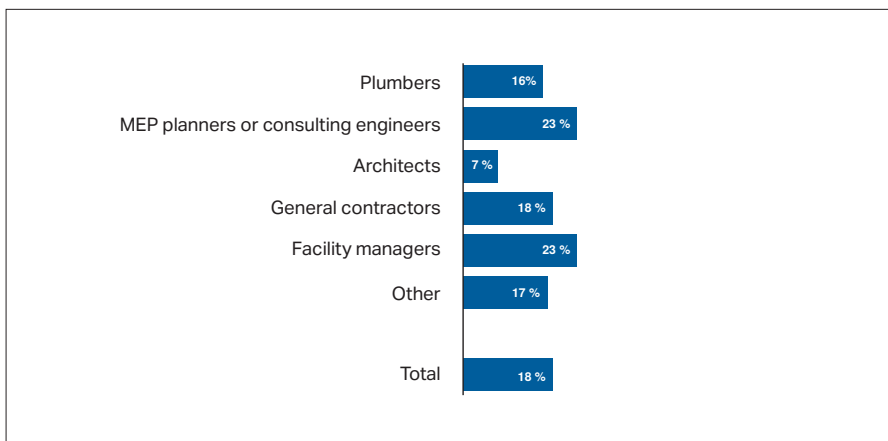



**Top 3 evaluation by country:**

Considering the Top 3 responses by country, IFC is the only standard, which is one of the Top 3 most preferred classification standards in all countries and regions, with the exception of the United Kingdom. Apart from IFC, VDI 3805 / ISO 16757 play an important role in Germany, Austria and Switzerland, while the

NBS standard is most frequently called for in Russia, the United Kingdom and the GISA. In Denmark (30 %), Switzerland (23 %), Russia (21 %) and Spain (20 %), the respondents were above average in often giving no opinion about standards for the classification of BIM content.

<b>Germany</b>		
1. Owner	52 %	
2. Architect	45 %	
3. General contractor	7 %	

<b>Austria</b>		
1. General contractor	51 %	
2. Owner	26 %	
3. Architect	9 %	

<b>Switzerland</b>		
1. Architect	50 %	
2. General contractor	17 %	
3. Owner	8 %	

<b>Belgium</b>		
1. Architect	28 %	
2. Owner	19 %	
3. General contractor	17 %	

<b>The Netherlands</b>		
1. General contractor	64 %	
2. Owner	43 %	
3. Architect	12 %	

<b>Denmark</b>		
1. General contractor	39 %	
2. Owner	13 %	
3. Architect	11 %	

<b>Sweden</b>		
1. Owner	71 %	
2. General contractor	15 %	
3. General management	7 %	

<b>Norway</b>		
1. General contractor	75 %	
2. Owner	25 %	
3. Architect	7 %	

<b>Finland</b>		
1. Owner	75 %	
2. General contractor	4 %	
3. Architect	3 %	

<b>UK</b>		
1. General contractor	50 %	
2. Owner	49 %	
3. Architect	28 %	

<b>Italy</b>		
1. General contractor	37 %	
2. Owner	16 %	
3. Architect / MEP	11 %	

<b>Spain</b>		
1. Owner	20 %	
2. General contractor	19 %	
3. Architect	16 %	

<b>France</b>		
1. Architect	60 %	
2. General contractor	15 %	
3. Owner	12 %	

<b>Poland</b>		
1. General contractor	29 %	
2. Owner	24 %	
3. Architect / MEP	21 %	

<b>Russia</b>		
1. General contractor	21 %	
2. Owner	19 %	
3. MEP planner	15 %	

<b>GISA</b>		
1. Owner	51 %	
2. MEP planner	25 %	
3. Architect	17 %	

**Do you use BIM content in accordance with the VDI 3805 / ISO 16757 standard?**

The majority of the respondents do not use BIM content in accordance with the VDI 3805 / ISO 16757 standard.

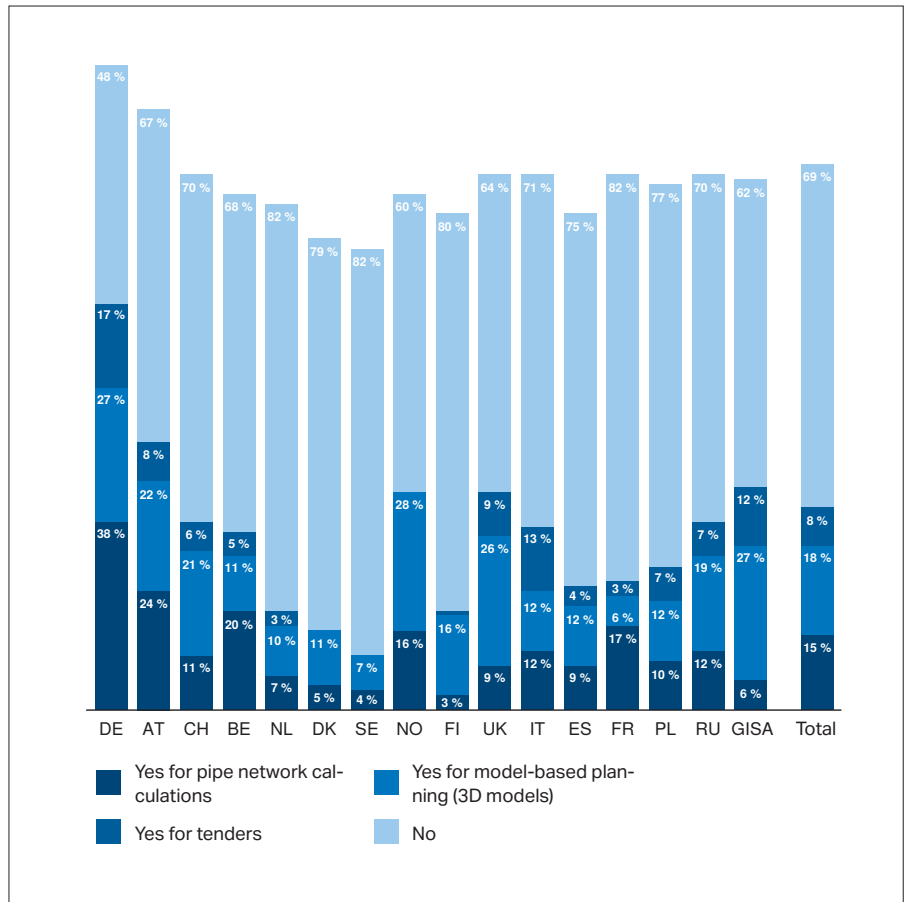

### Manufacturer-specific BIM content

Do you use manufacturer-specific BIM content directly made available by manufacturers in your BIM projects?

Evaluation by country:

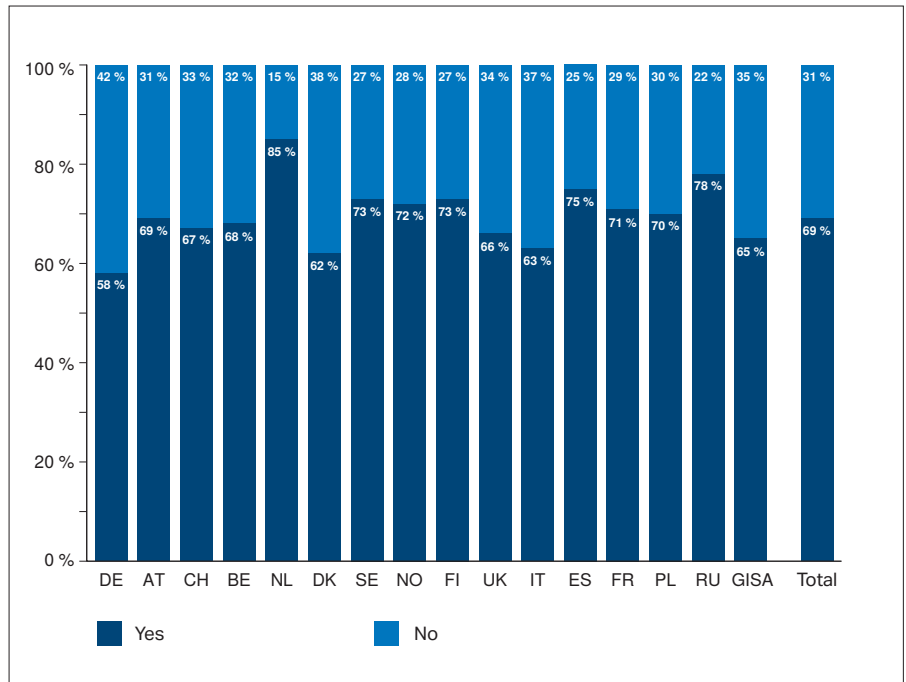

Evaluation by target group:

69 % of the respondents use manufacturer-specific BIM content made available by the manufacturer, which is used by all relevant target groups.

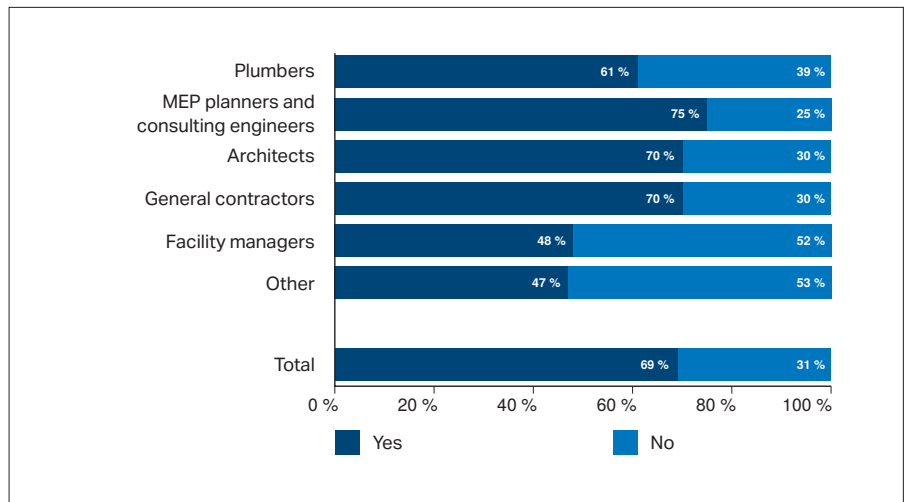

**Why do you not use manufacturer-specific BIM content in your BIM projects?**

The main reason for not using manufacturer-specific BIM content is the fact that this data needs to be manufacturer-neutral for design planning and tenders.

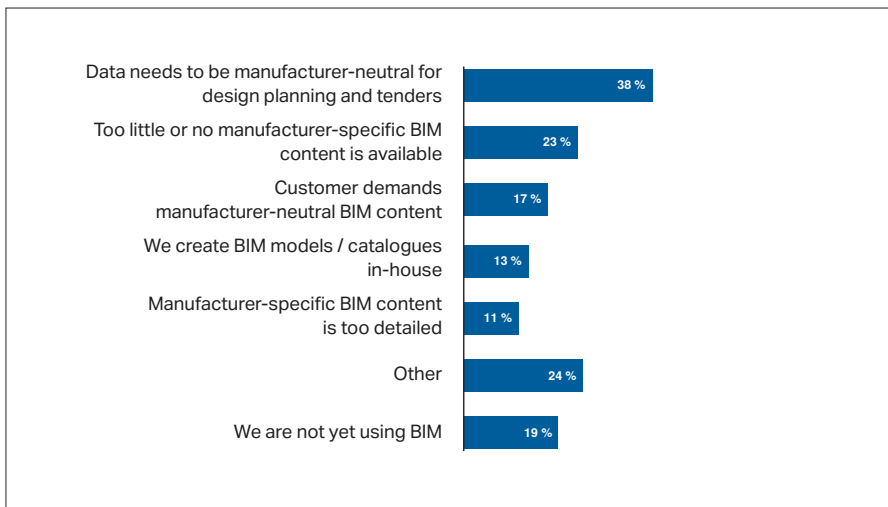

**Evaluation by country:**

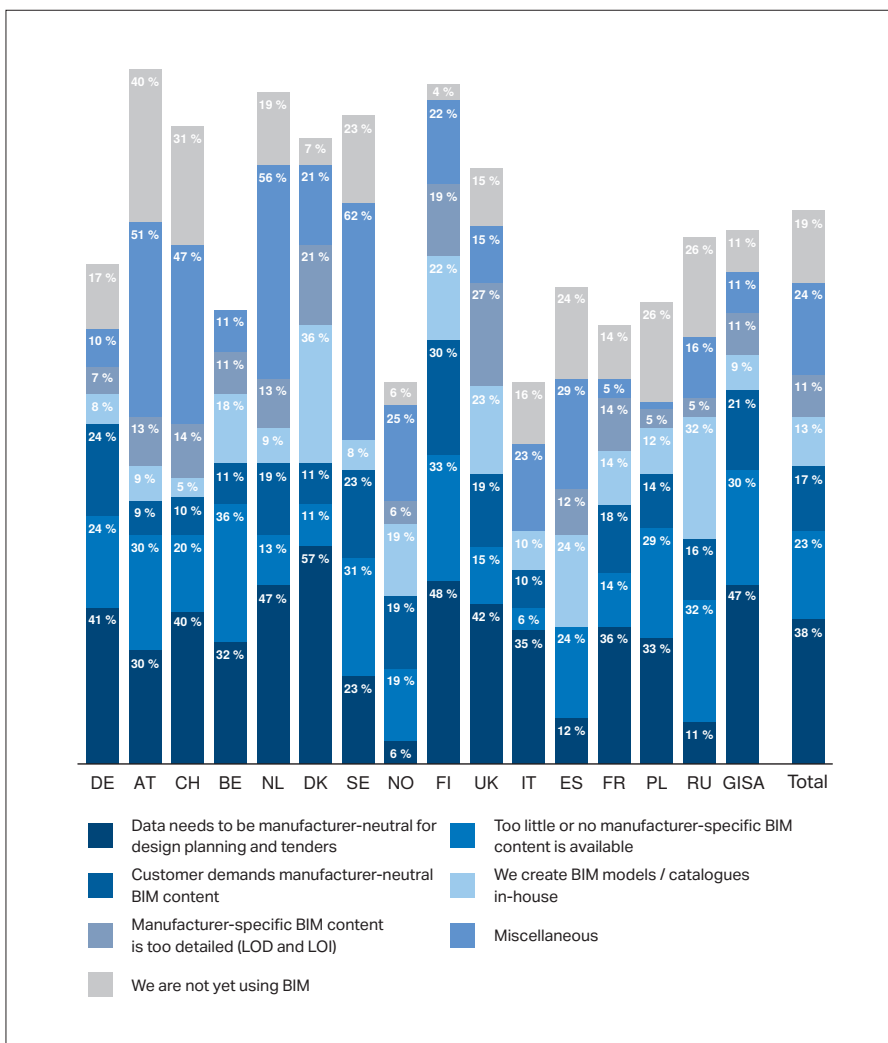

**Where do you get your manufacturer-specific BIM content?**

The majority of respondents procure their BIM content from the respective manufacturer's website.

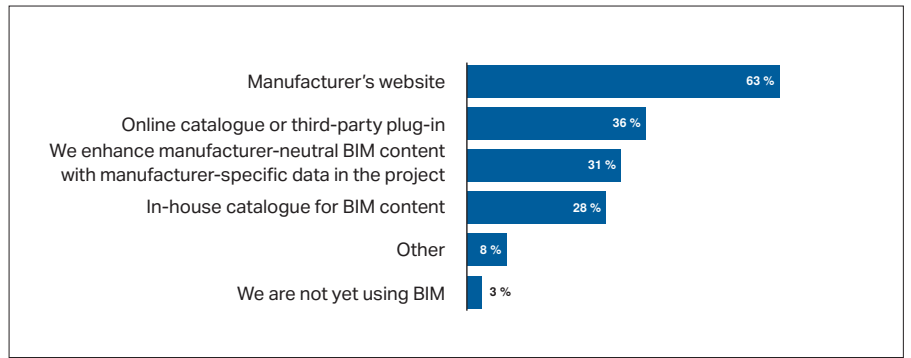

Evaluation by target group:

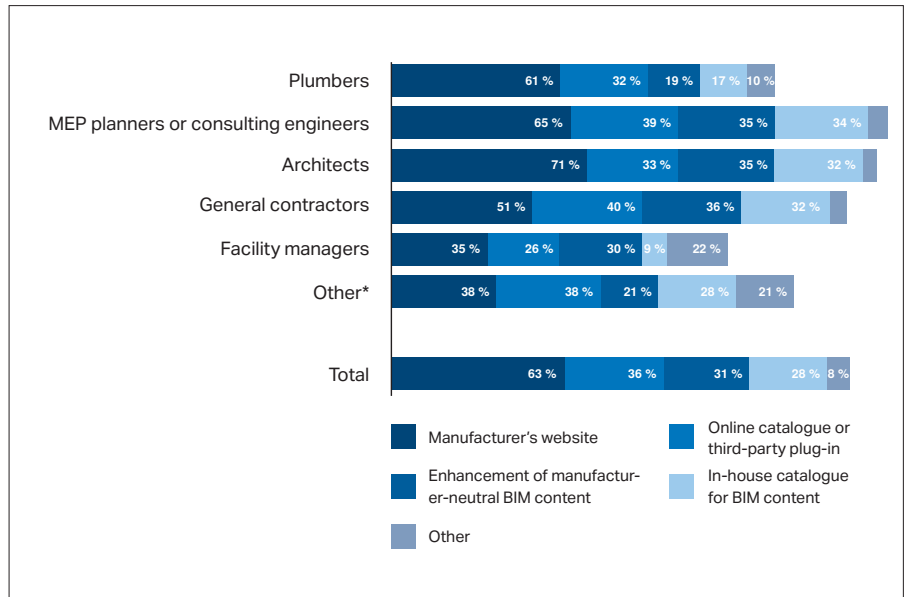

Evaluation by country:

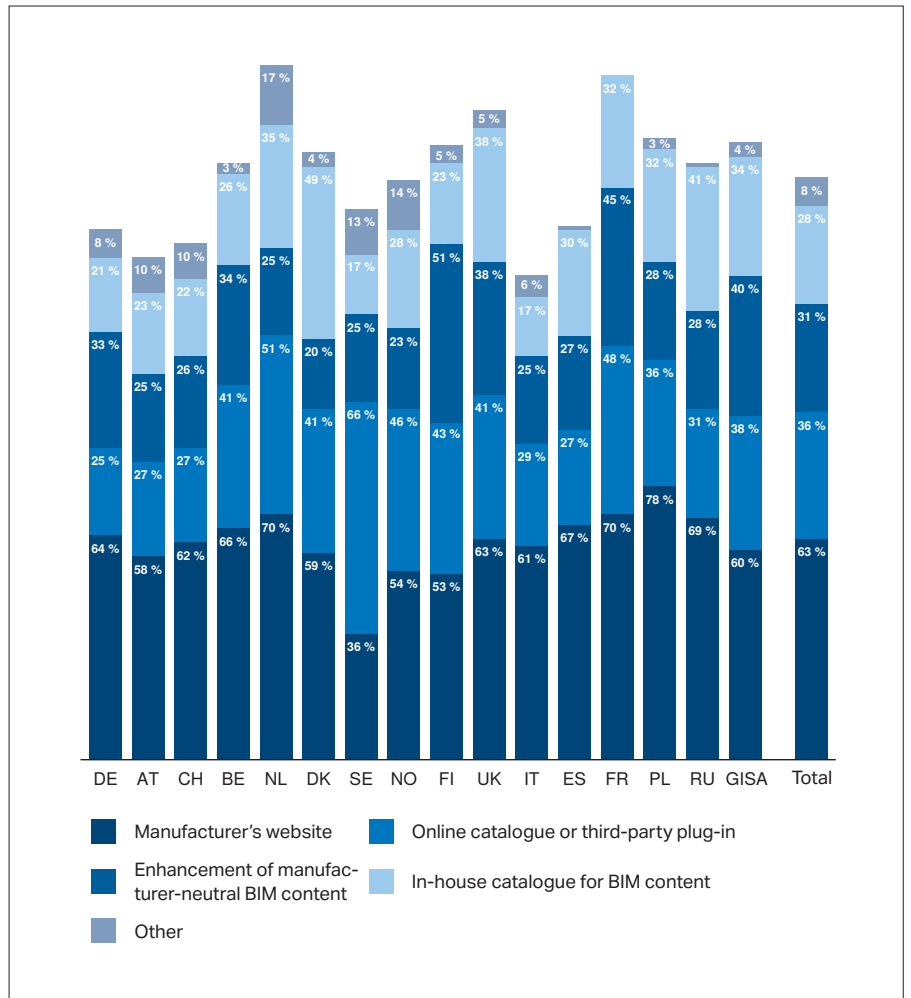



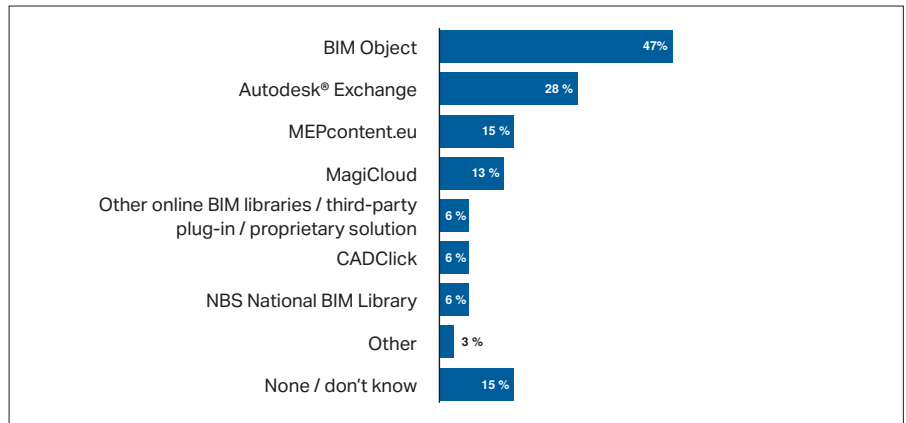

## Data sharing

On which online platforms or plug-ins do you rely?





Top 3 evaluation by country:

Germany		
1. Owner	50 %	
2. Architect	23 %	
3. General contractor	10 %	

Austria		
1. General contractor	46 %	
2. Owner	22 %	
3. Architect	10 %	

Switzerland		
1. Architect	49 %	
2. General contractor	21 %	
3. Owner	9 %	

Belgium		
1. Architect	41 %	
2. Owner	37 %	
3. General contractor	25 %	

The Netherlands		
1. General contractor	52 %	
2. Owner	40 %	
3. Architect	22 %	

Denmark		
1. General contractor	34 %	
2. Owner	29 %	
3. Architect	27 %	

Sweden		
1. Owner	62 %	
2. General contractor	27 %	
3. General management	15 %	

Norway		
1. General contractor	45 %	
2. Owner	32 %	
3. Architect	25 %	

Finland		
1. Owner	39 %	
2. General contractor	34 %	
3. Architect	16 %	

UK		
1. General contractor	47 %	
2. Owner	43 %	
3. Architect	38 %	

Italy		
1. General contractor	42 %	
2. Owner	36 %	
3. Architect / MEP	12 %	

Spain		
1. Owner	58 %	
2. General contractor	32 %	
3. Architect	8 %	

France		
1. Architect	62 %	
2. General contractor	32 %	
3. Owner	30 %	

Poland		
1. General contractor	59 %	
2. Owner	30 %	
3. Architect / MEP	16 %	

Russia		
1. General contractor	50 %	
2. Owner	46 %	
3. MEP planner	27 %	

GISA	
1. Owner	54 %
2. MEP planner	43 %
3. Architect	14 %

The majority of respondents are using BIM Object.

**Which data format do you prefer to use for data sharing?**

There is no clear picture about a preferred data format. Germany, Austria, Switzerland, Sweden and Finland prefer to use IFC as a data format. By contrast, other countries, such as Denmark, the United Kingdom, Italy, Spain, Poland, Russia and the GISA, are using native formats.

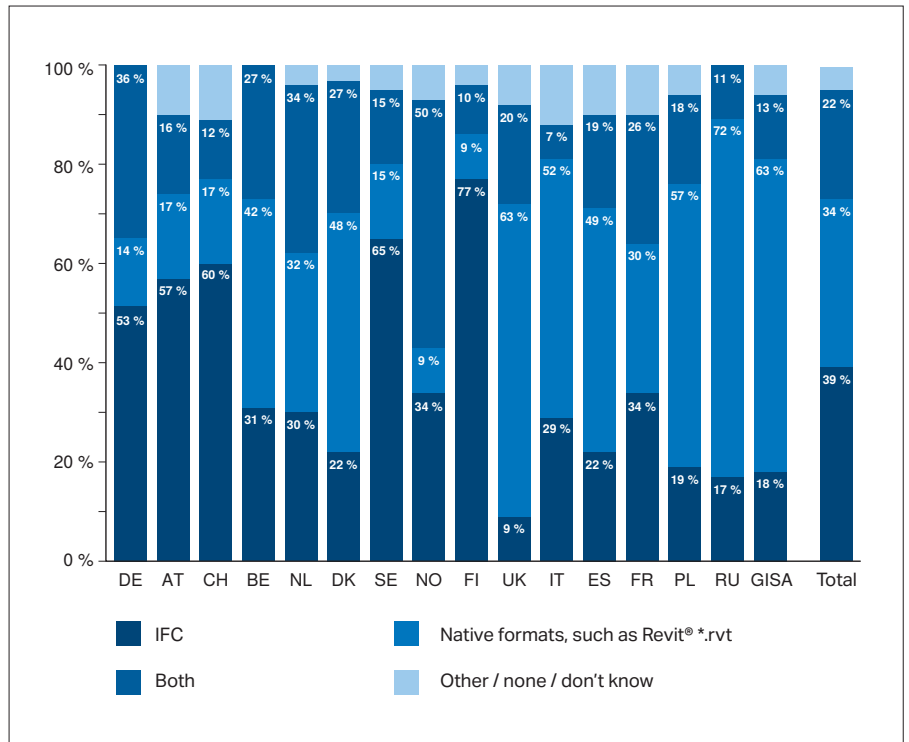

## 4.4 BODIES AND COOPERATIONS

### 4.4.1 Geberit in BIM bodies

Geberit is committed in many different ways to efficient and reliable MEP planning with BIM. For this reason, Geberit experts are actively involved in various bodies and initiatives and are making an important contribution to standardised data standards to significantly simplify digital planning in future:

- buildingSMART
- BTGA AK BIM
- Federal Association for Construction Systems – professional association
- Bauprodukte digital (products for bim)

Geberit is also working in close contact with educational and research institutes, such as the Burgenland University of Applied Sciences.

The Geberit Group's activities in different organisations:

- Geberit's BIM team is working with buildingSMART in the translation of designations and is providing terminology and translation services as a free contribution to the development of the IFC standard.



- Geberit's experts are working intensively with other manufacturers and representatives of other initiatives in the BIM working group at the BTGA in Frankfurt am Main on the expansion of the BIM classification model and the creation of all component-relevant properties of BIM objects. The objective of the collaboration is the completion and expansion of VDI 2552 Part 9 with an integrated data model, which takes into account all trades involved in the construction.



- In Germany, the local Geberit sales company has been represented in the working groups on Parts 21 and 29 of the VDI 3805 standard for many years.
- Since the end of 2018, Geberit has also been an active member of the "products for bim" initiative, which was established by various well-known manufacturers under the auspices of the "Federal Association of Construction Systems". The Geberit Group promotes, among other things, the use of common standards for construction product manufacturers' BIM objects with articles and active participation in various projects. The initiative also serves as a platform for an exchange of experiences with BIM amongst its members.



- Geberit experts also publish technical articles on current BIM issues from time to time in the "Bauprodukte digital" trade magazine.



- With technical lectures on current BIM issues from a manufacturer's point of view, Geberit is now a firm fixture at the annual "BIM Symposium", which is held at the Burgenland University of Applied Sciences in the Austrian town of Pinkafeld and so is contributing to the lively exchange between research and business.



- Geberit experts are regular speakers at events organised by the software manufacturer Autodesk®, including at the annual Autodesk® University and also at other professional associations, including the VDI.

## 4.5 GEBERIT DATA AND SOFTWARE SOLUTIONS

### 4.5.1 Classification of Geberit BIM objects

There needs to be a data standard, which the transmitting and also the receiving system understands, if data is to be shared between proprietary software systems.

As described in the chapter “buildingSMART”, on page 44, buildingSMART advocates manufacturer-independent and practical sharing formats for different aspects of information sharing within BIM under the buzz word “open BIM”. One of these sharing formats is the IFC standard (IFC = Industry Foundation Classes).

There are several versions of the IFC standard. IFC2x3 is the most widely used version and IFC4 is the latest version. IFC became an official ISO standard with the introduction of IFC4. The ISO 16739 standard: Industry Foundation Classes (IFC) regulates data sharing in the construction and facility management sectors. The IFC standard is essential for, among other things, merging discipline models to form a coordination model, and the same applies to working with reference models.

IFC is based on a schema in the form of an EXPRESS notation. It defines and structures geometric and also alphanumerical information. The schema definition is also available in an XML format (XSD) in addition to the EXPRESS notation. The schema uses templates or blueprints to describe the properties of the most diverse products or models, such as rooms, doors, walls, windows etc. in alphanumerical form. IFC can also be used to describe relationships between construction elements or assemblies.

However, unfortunately not all classes of sanitary components are described in the IFC standard. The Geberit Group therefore uses the IFC standard (IFX) set out in Part 9 of the VDI 2552 standard to classify Geberit BIM objects. The Geberit Group was and is heavily involved together with the BTGA (Federal Industrial Association of Technical Building Systems e. V.) in the development of the classification in Part 9 of VDI 2552.

A classification system to describe the properties of sanitary appliances is of great importance to the Geberit Group. Standardisation or classification simplifies data sharing between different software systems, at the same time as also facilitating the translation of metadata to other national data standards taken into account in national building standards. This allows the Geberit Group to supply customers with multilingual BIM objects. The Geberit Group currently makes available BIM objects in 24 languages.

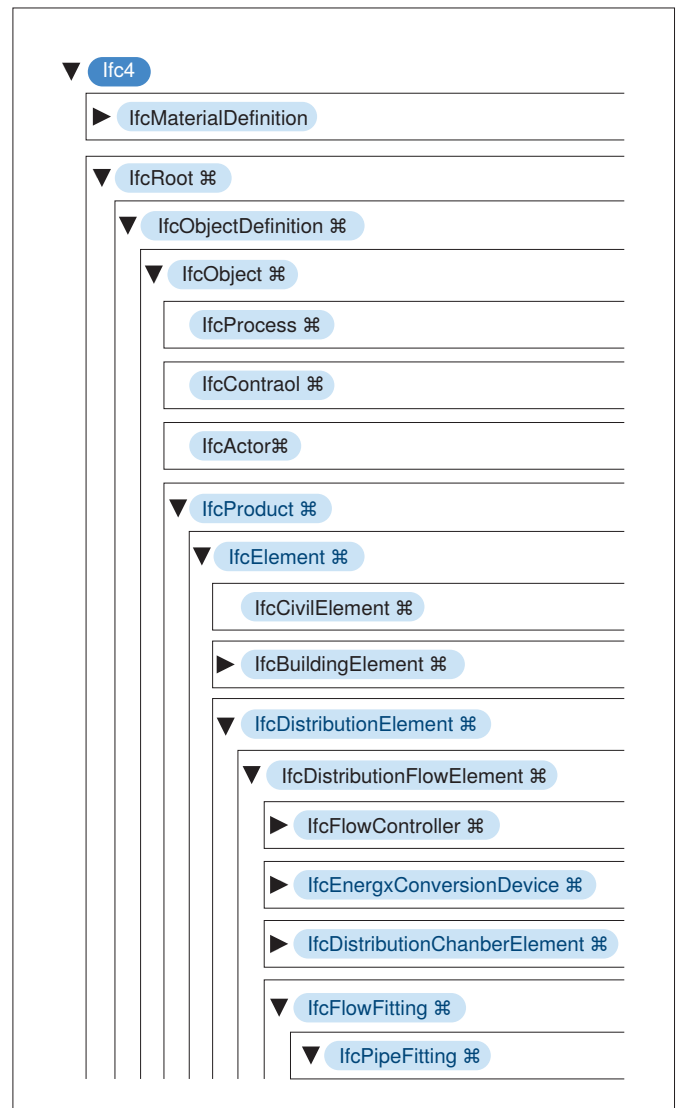

Figure 20: Classification of a fitting based on the advanced IFC standard (IFX)

## 4.5.2 Geberit BIM Catalogue plug-in

With its Geberit BIM Catalogue plug-in, Geberit is providing an innovative solution to many problems in MEP planning (MEP = technical building systems).

### BIM content – practical problems

Architects and sanitary engineers need BIM objects for their digital planning to equip their building models with them. They often encounter problems and obstacles.

#### Search for BIM objects on manufacturers' websites

Many construction product manufacturers provide BIM objects to download on their own websites. Architects and sanitary engineers download these BIM objects and, in certain circumstances, are disillusioned to find that the data may possibly be outdated, incomplete or, in the worst case, even incorrect. This is due to the fact that manual data maintenance is a very difficult and error-prone process. How is one supposed to manually keep thousands of data sets up-to-date, depending on the size of the product range? This is only possible at great expense and with extensive use of personnel, and yet is still prone to errors.

#### Search for BIM objects on third-party websites

It is possible to download BIM objects from many construction product manufacturers on dozens of platforms or databases online. But, once again here, the same problem arises: generally speaking, manual data maintenance. It is irrelevant whether a manufacturer's or a third party provider's employees are managing the BIM objects. Many of these platforms are simply catalogues from which users can download the required BIM objects, either against payment or free, depending on the business model. Of course, it would be desirable for the user of BIM objects to procure all BIM objects from all manufacturers in the one place and be certain that the BIM objects made available are also valid. Regrettably, the reality looks very different.

#### Local product ranges

There is an additional serious problem with the traditional methods of downloading BIM content from websites or online catalogues. The majority of manufacturers of construction products do not sell every product in every country. That is impossible from a regulatory standpoint alone, as there are different national requirements governing certified construction products in most countries. The Geberit Group supplies products to all parts of the world from its central warehouses, but the product range

looks very different in each country, i.e. not every product is available in every country. If this information is not available when downloading BIM objects, the user runs the risk that products are planned in a project, which are either not available or approved at the location of the project. If this is only established during the construction phase, it will inevitably lead to delays, as a new plan may be needed under certain circumstances. This results in additional costs, which the construction product manufacturer should actually bear.

#### Maintenance of proprietary BIM libraries

Out of necessity, many planning or architecture offices are setting up their own BIM libraries and maintaining BIM objects in-house. To do this, they need appropriately trained employees, who regularly check manufacturers' websites or online catalogues to keep the BIM content manually updated. This is an extremely time-consuming and error-prone process, as well as being an expensive process. Typing up information and pasting it into BIM objects is surely not "state of the art" in the age of digitalisation. However, often this is the only way to obtain valid and usable BIM objects.

#### Data language

The language of the metadata in BIM objects is an additional dimension of the complexity of BIM objects. The field lengths of attributes are often limited in some BIM authoring systems so that writers use abbreviations. However, it can lead to difficulties in understanding if the user of the BIM content is faced with abbreviations in a foreign language. In most cases, manufacturers use English when creating data, as it is assumed that English is widely understood everywhere. Offering BIM content in popular languages worldwide equates to a massive effort for the manufacturer, as the number of data sets to be updated would increase hugely. English is therefore used as the universal language.

#### Information density

A large number of the available BIM objects do not include sufficient information needed for the planning, construction and operation of a building. Why should they? There is no binding or applicable definition about what can be regarded as the minimum requirement of information needed in a BIM object. Often architects or sanitary engineers need to subsequently add this information to the BIM content sets during the planning process. This is error-prone and inefficient.

### Manufacturer-specific versus manufacturer-neutral BIM objects

The customer generally demands generic information and BIM objects in the planning and tendering of public sector projects so that manufacturer-specific BIM objects cannot be planned in the model until after the conclusion of the tender process. This leads to either the generic BIM objects remaining in the models and then being subsequently enhanced with manufacturer-specific metadata, or the generic BIM objects being replaced by manufacturer-specific BIM objects during the execution planning stage. Neither is a workflow for efficient digital building planning.

### Centralised data management

The following maxim applies at Geberit: "One data source for everything", i.e. all data needs to be maintained on a centrally managed database, the Geberit internal Product Information Management System (PIM) and supplied from there. All information channels from the online catalogue and technical documentation, to mobile end devices and printed product catalogues, receive their product data from one and the same PIM system. It is therefore only logical to also host the BIM objects and BIM-relevant metadata on this system and to make it available from there: consequently a "Single Source of Truth".

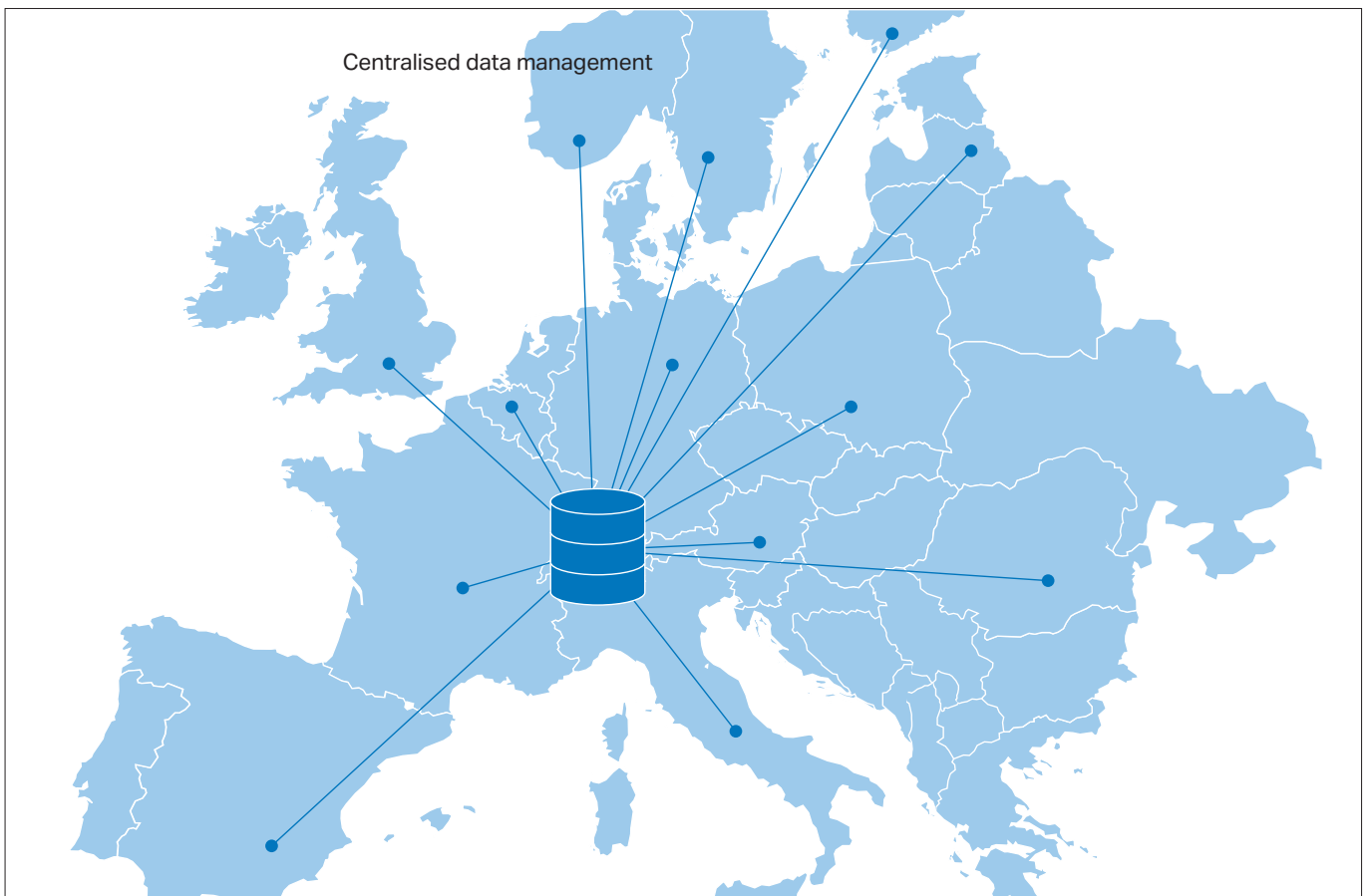

Figure 21: One central data source: „Single Source of Truth“

### The Geberit BIM Catalogue plug-in

Geberit offers its users an innovative tool, unique in this form with its Geberit BIM Catalogue plug-in for Autodesk® Revit®. Following a free download from the local Geberit website, the plug-in can be very simply installed directly in the Revit® authoring software. After installation, the user can access the Revit® application for BIM objects for Geberit products and, by double-clicking on them, plan them into his model. This removes the need to laboriously search for individual BIM objects on websites or different platforms.

The Geberit BIM Catalogue plug-in offers users the following benefits:

- The latest BIM objects at any time – no more outdated BIM content!
- Country-specific BIM objects – BIM objects always correspond to the local product range!
- The plug-in only downloads Revit® families (\*.rfa) – no more confusing product files (\*.rvt)!
- Piping systems are completely downloaded by double-clicking on them – no more need to locate separate components!
- Hierarchical product structure similar to the Geberit online catalogue – simple search for products!
- BIM objects in your local language – the Geberit BIM Catalogue plug-in currently supports the following countries and languages:

Country/product range	Language 1
Germany	German
Switzerland	German
	French
	Italian
Austria	German
France	French

Country/product range	Language 1
Italy	Italian
The Netherlands	Dutch
Belgium	French
	Dutch
Luxembourg	French
United Kingdom	English
Poland	Polish
Czech Republic	Czech
Slovakia	Slovakian
Romania	Romanian
Hungary	Hungarian
Russia	Russian
Ukraine	Ukrainian
	Russian
Slovenia	Slovenian
Croatia	Croatian
Serbia	Serbian
Spain	Spanish
Portugal	Portuguese
Norway	Norwegian
Finland	Finnish
Estonia	Estonian
Lithuania	Lithuanian
Latvia	Latvian
India	English
Gulf Region	English
Turkey	English
Southeast Asia	English
North Africa	English
	French
South Africa	English

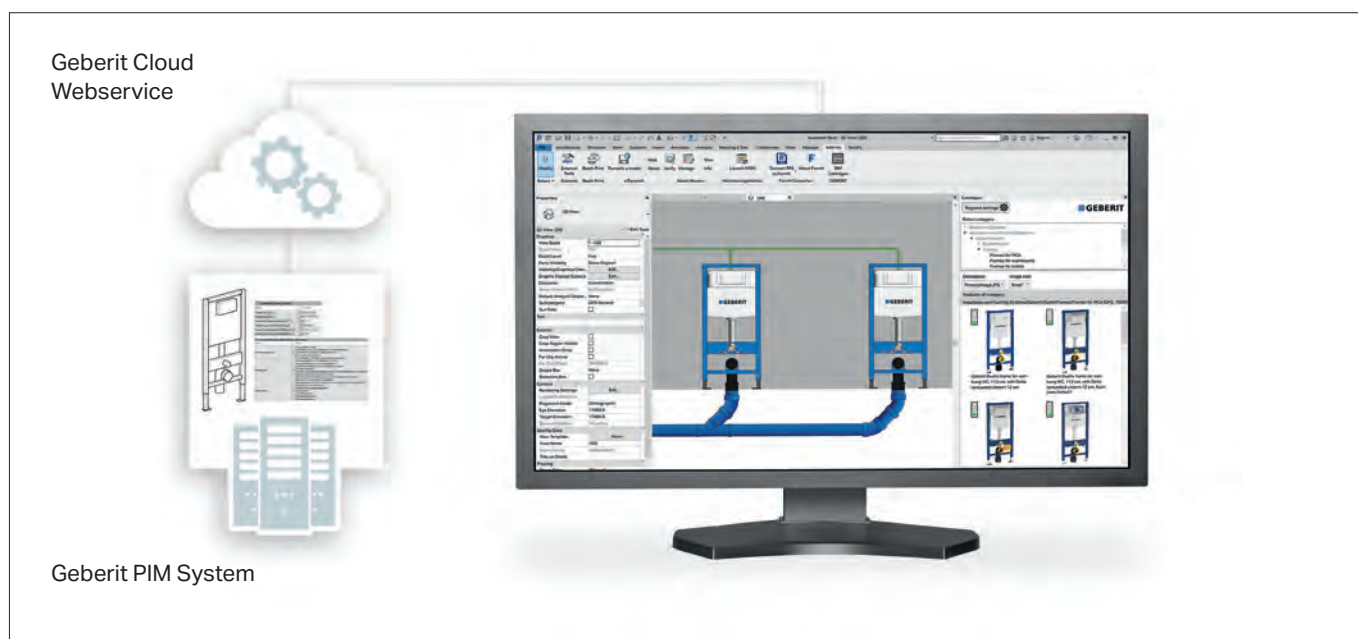

Figure 22: Functional diagram of the Geberit BIM Catalogue plug-in

## Efficient planning with manageable BIM objects

Geberit relies on highly simplified, parametric geometries with all the metadata that is relevant for planning in the background. This avoids overloading CAD systems from the outset and allows for efficient planning. The BIM objects for Autodesk® Revit® are made available as so-called "Revit® families" and not as project files. Simply double-clicking on them in the Geberit BIM Catalogue plug-in enables all dimensions for a pipe system and the relevant fittings to be downloaded into the active project. That means everything that's required for efficient planning, but without all the unnecessary data. When special fittings are needed, they can be selectively found in the catalogue.

Installation elements are also structured on the basis of parameters as far as possible, providing huge added value in the planning process: All settings possible on the installation element can also be visualised in the planning. Among other things, the frame height or connection bend angle can be adjusted in the properties. The connection width of the fastening screws can also be adjusted in order to use as many ceramic models as possible during planning.

## Reliable planning with the latest BIM objects

The direct connection to the Geberit product database ensures that the user only uploads tested and approved BIM objects. Incorrect or obsolete BIM content is therefore a thing of the past. Geberit has implemented a multi-stage quality assurance process to validate the BIM objects, which ensures that BIM objects are only available after strict quality control and approval by internal experts.

## Manufacturer-neutral tenders

As a rule, tenders in public sector projects in the EU need to be manufacturer-neutral. Geberit has a simple solution for this: the BIM objects can be converted to "manufacturer-neutral/generic" at the click of a button. The relevant attributes are then filled with generic descriptions. Following a tender, these attributes can be converted back to manufacturer-specific parameters again at the click of a button. This function does away with the painstaking task of replacing BIM objects in the BIM model and significantly reduces the amount of work required.

## Local product catalogue

The Geberit BIM Catalogue plug-in provides maximum possible reliability in the selection of the right products. Pre-selecting a country or region ensures that only those products that are available in the pre-selected country or region are included during planning. The Geberit BIM Catalogue plug-in can be used worldwide thanks to this function.

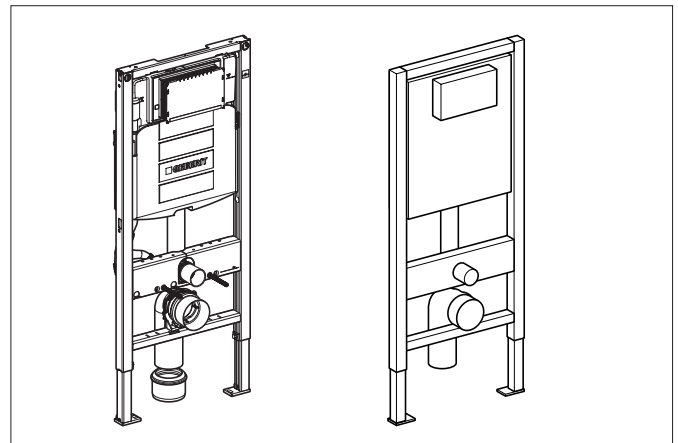

Figure 23: From complex and static to simple and parametric

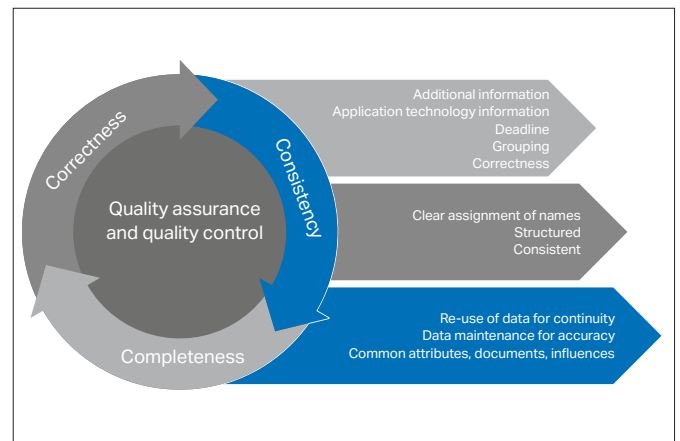

Figure 24: Geberit quality assurance process

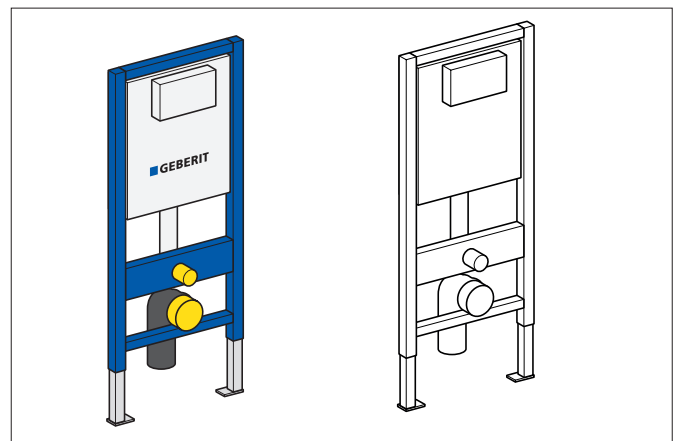

Figure 25: Manufacturer-specific versus manufacturer-neutral

## BIM objects in the local language

In addition to the region, the local language can also be set in the Geberit BIM Catalogue plug-in so that the BIM models are automatically translated into the selected language. Geberit currently offers BIM objects in over 20 languages.



### 4.5.3 Geberit ProPlanner

#### Overview

Geberit has developed a planning and calculation software to ensure that MEP planners and plumbers can plan as simply as possible with Geberit products: Geberit ProPlanner.

Geberit ProPlanner enables sanitary installations to be planned quickly, simply and reliably. In addition to planning-assisting functions, sub-divided into different modules, Geberit ProPlanner also has innovative calculation algorithms, e.g. for the standard design of piping systems.

The use of Geberit ProPlanner reduces planning work and hence reduces the time needed. Causes of faults can therefore be eliminated in the planning phase.

Geberit ProPlanner is tailored to the needs of planning plumbers and sanitation companies who take care of the planning of medium- to large-sized projects themselves.

#### Structure

Geberit ProPlanner can be used to plan the following sanitary systems:

- Geberit Duofix and Geberit GIS installation systems
- Geberit Mepla, Geberit PushFit, Geberit Mapress supply systems
- Geberit PE, Geberit Silent-db20, Geberit Silent-Pro, Geberit Silent-PP drainage systems
- Syphonic roof drainage system Geberit Pluvia

The software consists of 4 modules:

- Installation systems
- Schematic planning (supply and drainage systems)
- Detailed planning 3D
- Roof drainage

The standard version of Geberit ProPlanner includes the Installation systems module. Schematic planning, Detailed planning 3D and Roof drainage are offered as add-on modules. The add-on modules enable reliable detailed and concept planning, the creation of scaled 2D floor plans, the conversion of 2D floor plans into 3D visualisations and calculations based on hydraulic lists.

## Installation systems module

The Installation systems module permits the fast and efficient planning of Geberit Duofix and Geberit GIS systems. The planning and calculation functions are based on the latest regulations and Geberit products. The product data is integrated directly from the Geberit product information systems, ensuring a high level of planning reliability. Cost estimates, specifications of services and quotations can therefore be simply produced.

Planning wizards help with the input of project and building data when creating a project. Installation walls can be added to the project manually or automatically. Parameters, such as the wall type, wall coupling, dimensions and wall properties, provide for the detailed configuration of the installation walls. The sanitary appliances needed are simply drawn by drag and drop from the toolbox into the design area window with the installation wall to be planned. A message list draws the user's attention to key information and possible errors during the planning.

There are also extensive processing and export options available once an installation wall has been completely planned. A material and cost summary lists the material quantity required, article numbers, individual and total prices and the installation time. The GAEB interface enables the lists determined to be transferred to tender programs. The print output contains material lists, cost estimates, installation manuals, cut lists and simple graphic prints. The data can be transferred to the Detailed Planning 3D module for detailed planning. Export is available in the form of a 3D CAD file for further processing of the data in CAD programs, like AutoCAD.

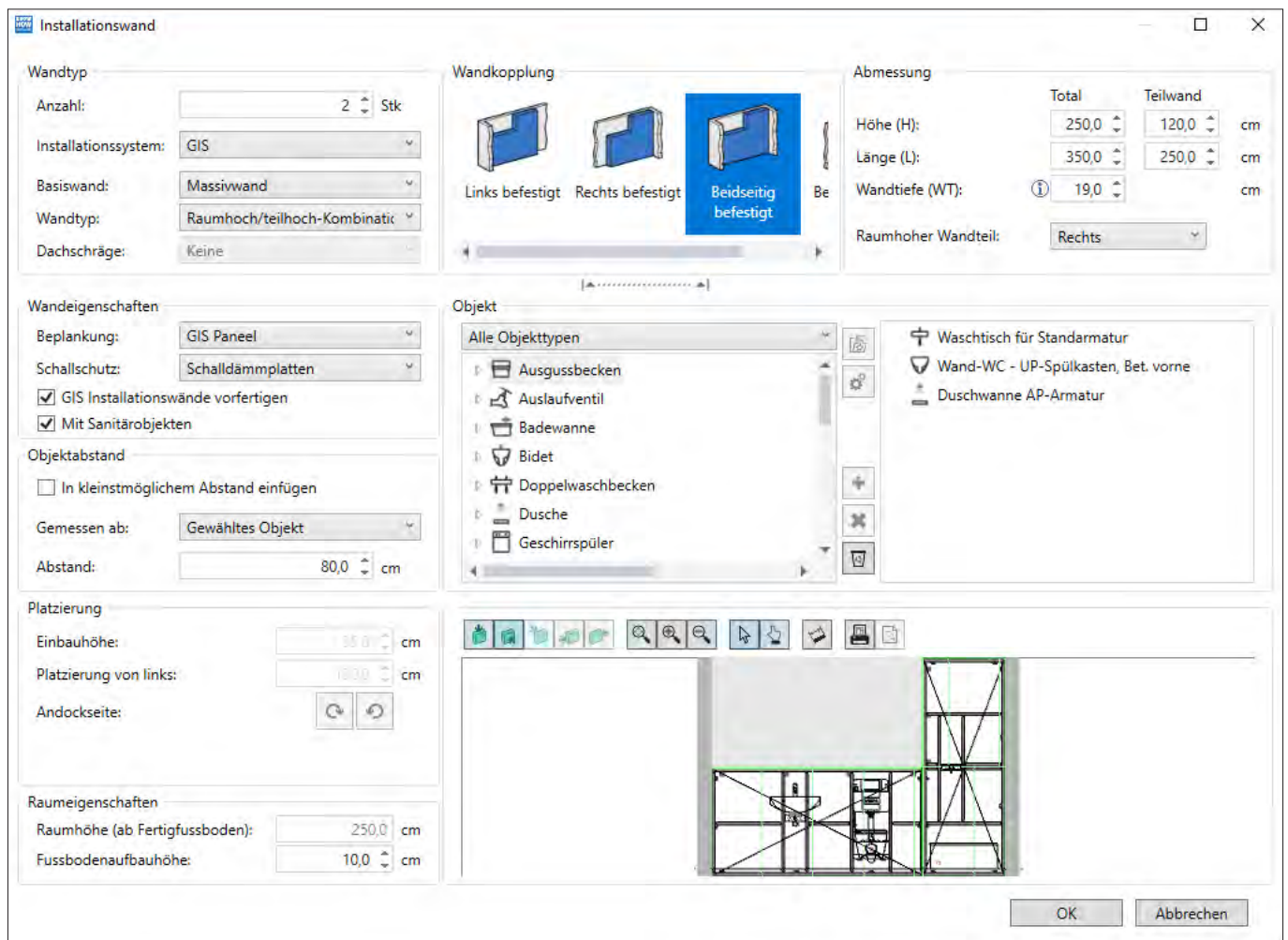

Figure 26: Planned Geberit GIS installation wall with washbasin, WC and shower (preview of 3D CAD export)

### Schematic planning module

The Schematic planning module enables drinking water, heating and drainage systems to be planned directly in the schematic drawing. It provides a detailed visual display of your plan. These planning functions are also based on the latest regulations and Geberit products. The product data is directly integrated from the Geberit PIM system.

Planning wizards help with the input of project and building data when creating a project. All popular objects from drinking water, heating and drainage systems, such as sanitary appliances, valves or water meters, can be placed simply and quickly in the schematic drawing. The pipe system is drawn by connecting the objects.

Once the pipe system has been planned with all the required objects, the module allows the system to be calculated. A message list draws the user's attention to key information and possible planning errors. The calculation results, e.g. pipe dimensions, can be visualised as labels in the schematic drawing.

There are also extensive processing and export options available once the planning has been completed. Material, parts, hydraulic and quotation lists can be outputted automatically. The schematic drawing thus created can be printed as a schematic drawing. A CAD export interface (Autodesk® RealDWG®) for the formats DXF/DWG is available for processing the data in CAD programs.

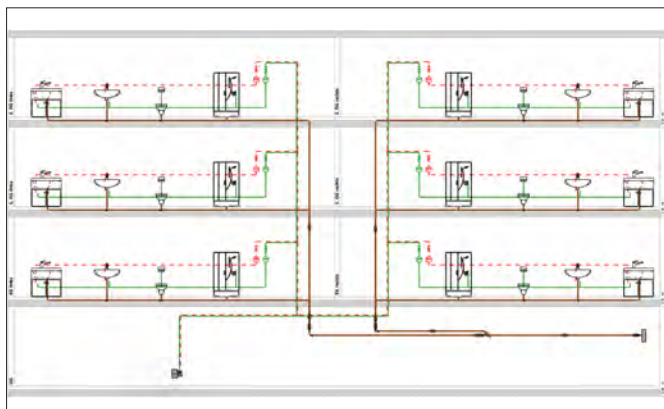

Figure 27: Planning a drinking water installation in the schematic drawing

### Detailed planning 3D module

The Detailed planning 3D module enables the detailed planning of Geberit installation walls with the associated sanitary appliances. Wall/floor openings, like windows or doors, can also be inserted. A dimensioned floor plan, a front view and a 3D view are available as views.

Complex rooms can be planned with this module. The planning functions are based on the latest regulations and Geberit products and the product data is integrated directly from the Geberit product information system.

Planning wizards help with the input of project and building data when creating a project. A project can therefore either be set up as an empty project or based on an architectural plan. An architectural plan can be imported using the integrated DXF/DWG interface if the files to be imported are available as AutoCAD, DXF/DWG, SVG or JPG files etc. The import function therefore enables close collaboration with the architect and/or the sanitary engineer. The planning can also be carried over from the Installation systems module. The planned installation project can be dimensioned in the 2D floor plan and front view, either automatically or manually. The drawing scale can be defined variably so that the project can be ideally fitted into the print area. The project or parts of it can be enlarged or minimised, moved or turned in the virtual three-dimensional space.

There are also extensive processing and export options available once an installation project has been completely planned. The print output includes parts, cut and price lists as well as installation plans. The created installation project can be outputted as a floor plan, front view, 3D and installation drawing. Export is available in the form of a 3D CAD file for further processing of the data in CAD programs, like AutoCAD.



Figure 28: 3D view of a fully planned installation wall

## Roof drainage module

The Roof drainage module enables the optimum hydraulic and economic planning and dimensioning of Geberit Pluvia roof drainage systems, which draw rain water by negative pressure from the roof. The module is based on the latest regulations and standards as well as the Geberit PE, Geberit Silent-db20 and Geberit Pluvia product ranges. The product data is directly integrated from the Geberit product information system.

The module visualises all planning steps in an isometric view. This provides an optimum visual insight into the roof drainage system to be planned. The CAD data of the roof construction can be imported via an import interface and visualised geometrically. The roof area, number and performance of roof outlets and the length and dimension of the pipe system are calculated automatically. An editing function allows pipe lengths and dimensions to be changed with just a few clicks of your mouse. The hydraulic features of the roof drainage system are set out in a hydraulic list. Selected parameters can be shown using colour coding, enabling the user to see at a glance, for instance, the pressures or flow velocities prevalent in the various pipe sections. The roof drainage system fastenings suggested by the software can also be shown.

The module automatically creates quotation, material and hydraulic lists that comply with the requirements of the latest standards. The entire project can be displayed as an isometric drawing or can be exported into other CAD programs (Autodesk® RealDWG®) via the CAD export interface.

## Licensing

Geberit ProPlanner is available to download free from all Geberit sales company websites. Once it has been installed and registered once, the user receives a licence key, which activates the Installation systems module.

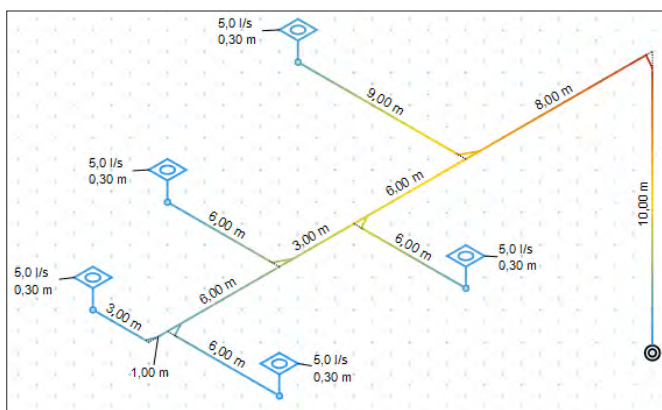

Figure 29: Roof drainage project with colour coding

## 4.5.4 Geberit Pluvia plug-in for Autodesk® Revit®

### Overview

The Geberit Pluvia plug-in integrates the planning and dimensioning of Geberit Pluvia roof drainage systems into the world's most widely used BIM software Autodesk® Revit®.

The plug-in enables the hydraulics of the roof drainage system to be calculated directly in Autodesk® Revit®. In the same way as the Roof drainage module in Geberit ProPlanner, the plug-in provides a hydraulic calculation of the roof drainage system.

The Geberit Pluvia plug-in for Autodesk® Revit® therefore provides for planning and calculation in a single software environment. The additional work involved in dimensioning Geberit Pluvia in Geberit ProPlanner and then transferring the dimensioned system into Autodesk® Revit® is now a thing of the past. There is no longer a need to jump between different software solutions during the BIM planning process.

### Function

The Geberit Pluvia plug-in for Autodesk® Revit® permits the optimum hydraulic and economic planning and dimensioning of Geberit Pluvia roof drainage systems. The plug-in is based on the latest regulations and standards as well as the Geberit PE, Geberit Silent-db20 and Geberit Pluvia product ranges. The product data is directly integrated from the Geberit PIM system. The plug-in is integrated seamlessly into Autodesk® Revit® via a user-friendly menu bar.

The roof drainage system including the roof outlets needs to have been constructed in Autodesk® Revit® to dimension Geberit Pluvia with the Geberit Pluvia plug-in for Autodesk® Revit®. The performance of the roof outlets and the length and dimension of the pipe system are calculated automatically. Automatic calculation is initiated by <Calculate> in the menu bar. To do this, the Geberit Pluvia plug-in sends the output data of the roof drainage system to the Geberit Cloud, where the system is calculated by artificial intelligence. The drawn roof drainage system is automatically adapted in Autodesk® Revit® on the basis of the calculation results. An editing function allows pipe lengths and dimensions to be changed with just a few clicks of your mouse.

The calculation enables the plug-in to automatically create quotation, material and hydraulic lists that comply with the requirements of the latest standards. The plug-in also displays the project as an isometric drawing in which the system components and their dimensions are visualised. Lists and drawing are available as a PDF or Excel file.

### Licensing

The use of the Geberit Pluvia plug-in for Autodesk® Revit® requires a valid Geberit ProPlanner licence. The licence file can be exported via licence management from Geberit ProPlanner.

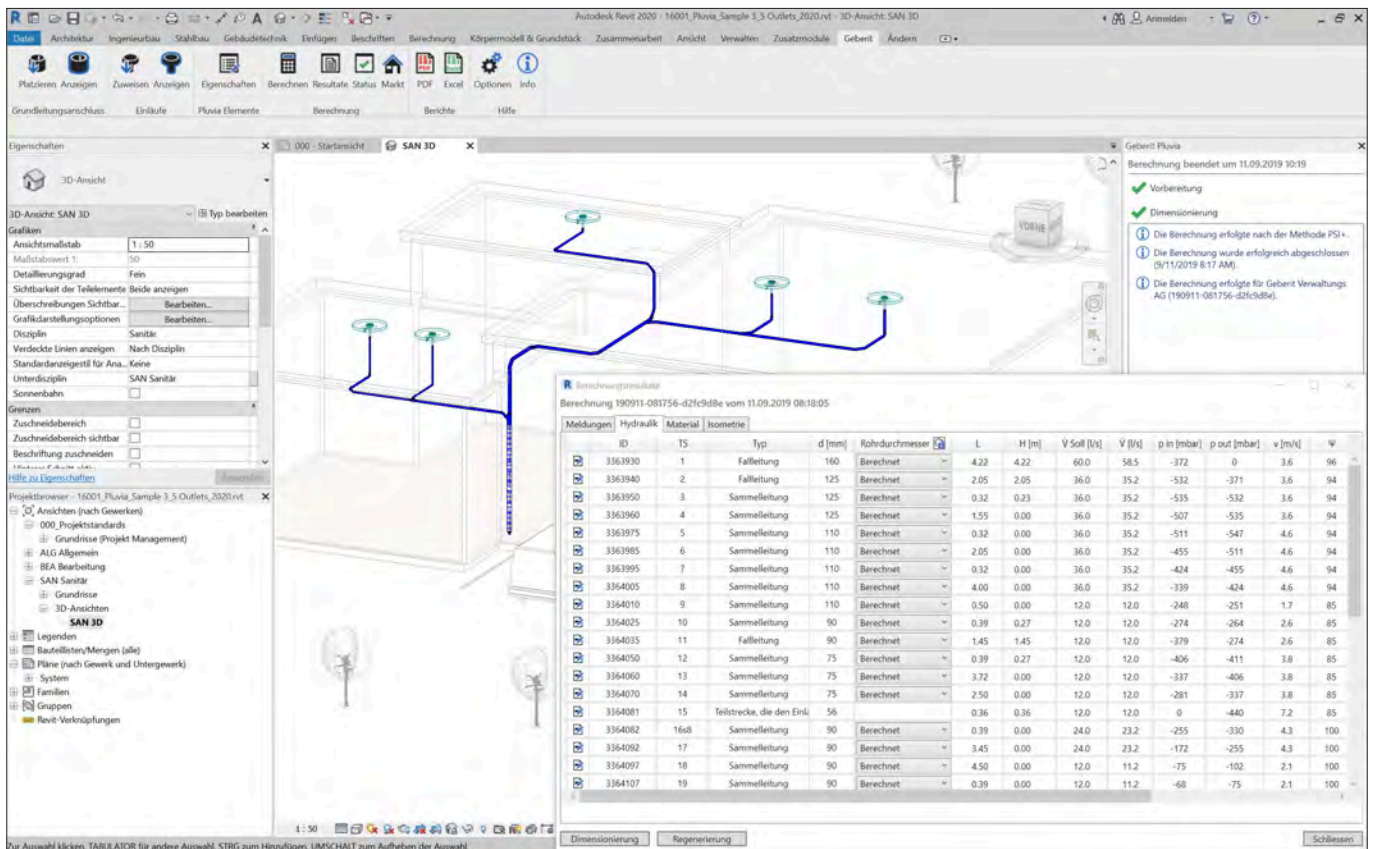
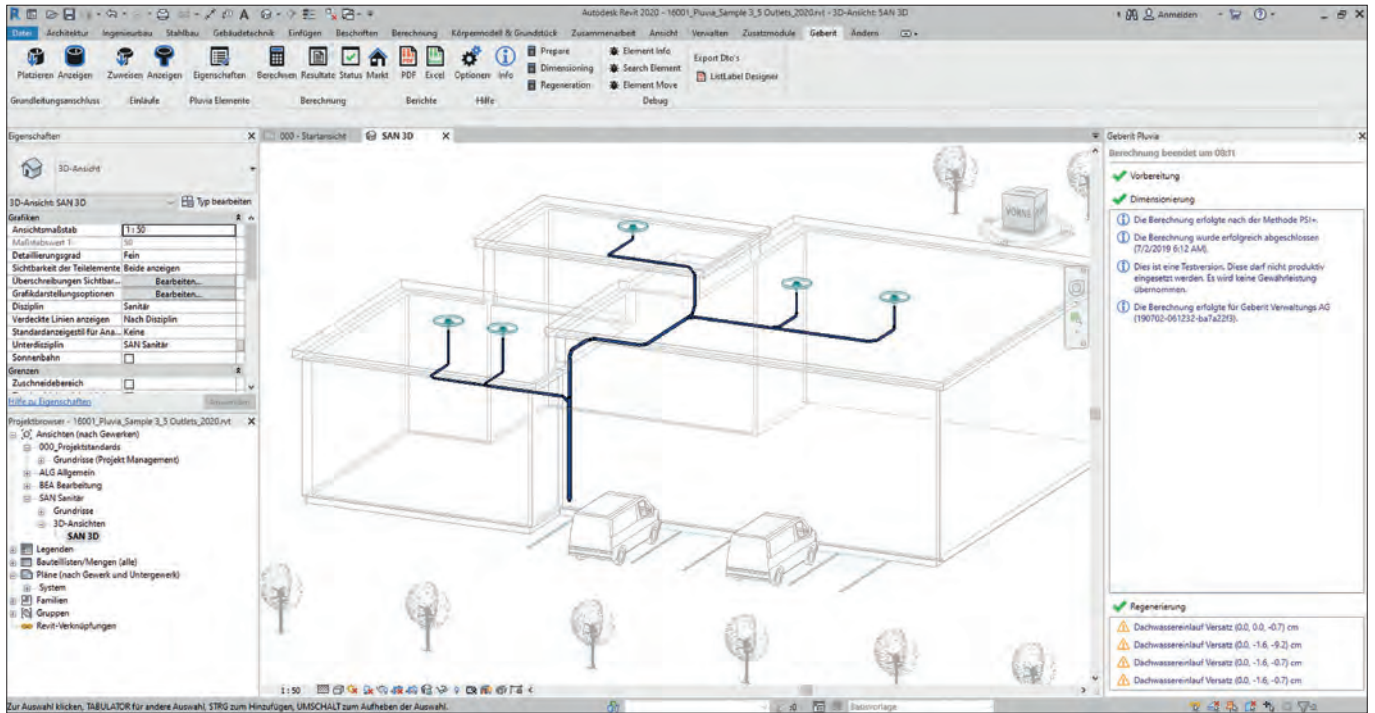

Figure 30: Geberit Pluvia plug-in for Autodesk® Revit®

**Geberit International Sales AG**  
CH-8640 Rapperswil  
Switzerland

[sales@geberit.com](mailto:sales@geberit.com)

[www.international.geberit.com](http://www.international.geberit.com)